



Freedom

USER MANUAL

Nitrox, Trimix & CCR dive computer



Divesoft Freedom User Manual

Nitrox, Trimix & CCR dive computer

Author

Divesoft s.r.o

Publisher

Divesoft s.r.o.

www.divesoft.cz

Issue

Version 2.03

17. November 2015

Use of this manual approved by

Lucie Šmejkalová, CEO

Introduction

Use of this manual

The Divesoft Freedom is intended for use exclusively by a trained person who is capable of fully understanding the instructions contained in this manual.

The technical documentation is subjected to a process of continual development and improvement. Therefore, please regularly check the website at www.divesoft.cz for updates.

This manual provides operating instructions for the hardware and software (firmware) version of the Divesoft Freedom written on the title page.

Safety

Warning: This computer calculates a decompression profile using a mathematical model. It does not know your specific physiological decompression requirements.

There is always a risk of decompression sickness (DCS) for any dive profile even if you follow the dive plan prescribed by dive computer. No procedure, dive computer or dive table will prevent the possibility of DCS or oxygen toxicity!

Warning: Use backup instruments! Ensure that you have access to backup instruments to measure depth and time. Ensure that you have access to a backup method of decompression profile calculation. Never risk your life on only one source of information.

Warning: Always check the device before diving in order to ensure that the display works, the device has not run out of battery power and all settings are correct.

Warning: All software contains bugs and the firmware of the Divesoft Freedom is no exception. The computer can probably do unintended things.

Warning: This computer may malfunction at any time. The question is not whether it will fail but when it will fail. Always have a plan on how to handle failures.

Responsibility of the Divesoft Freedom user

A Divesoft Freedom user must accept the fact that diving involves risk. Adherence to everything that the user has learned in the Divesoft Freedom's technical documentation and in training can reduce the risk but cannot eliminate it. Safety when diving is further enhanced by regular training, methodical education and adherence to good diving practices. Technical diving requires a far higher degree of care and discipline than recreational diving.

If you do not accept the risk and you are not a trained, careful and disciplined diver, do not dive with the Divesoft Freedom.

Upgradable computer

Features of the Freedom versions

Version	Mixtures	Air	Nitrox	Oxygen	Trimix	Rebreather
Advanced Bottom Timer	–	–	–	–	–	No
CCR Bottom Timer	–	–	–	–	–	Yes
Basic Nitrox	1	Yes	max. 40%	No	No	No
Advanced Nitrox	3	Yes	Yes	Yes	No	No
Full Trimix	9	Yes	Yes	Yes	Yes	No
Closed Circuit	9+8 dil.	Yes	Yes	Yes	Yes	Yes

Hardware of all versions of the Divesoft Freedom computer is the same¹. Only the software differs. The software version can be upgraded.

Pictures in this manual are based on the Closed Circuit version of the Divesoft Freedom. Limitation of other versions are mentioned in the text.

¹ The Closed Circuit version includes a cable for connection to rebreather O₂ sensors.

Contents

Introduction	3
Upgradable computer	4
Features of the Freedom versions	4
Section 1: Quick start guide	8
Section 2: Operation	9
2.1 Control elements	9
2.1.1 Meanings of inputs in surface modes	9
2.1.2 Meanings of inputs in dive modes	9
2.1.3 Language	10
2.2 Brightness control	10
2.3 Switching on the unit	10
2.4 Switching off the unit	10
Section 3: Diving	12
3.1 Surface mode	12
3.1.1 Entering surface mode	12
3.1.2 Surface mode screen	12
3.1.3 Switching to other modes	13
3.2 Open Circuit	13
3.2.1 Entering open circuit mode	13
3.2.2 Detailed screen	13
3.2.3 Synoptic screen	17
3.2.4 Big Screen	18
3.2.5 Dive profile screen	18
3.2.6 Dive menu	18
3.2.7 Gas switch shortcut	19
3.3 Fixed setpoint CCR	20
3.3.1 Pre-dive and submersion	20
3.3.2 Setpoint	20
3.3.3 Dive menu	21
3.3.4 Stack time	22
3.4 Measured CCR	22
3.4.1 O ₂ sensors connection	22
3.4.2 O ₂ sensors calibration	22
3.4.3 pO ₂ reading	23
3.5 Gauge	23
3.5.1 Synoptic screen	23
3.5.2 Big Screen	24
3.5.3 Dive profile screen	24
3.5.4 Dive menu	25
3.6 Free	26
3.6.1 Surface screen	26
3.6.2 Dive screen	27
3.7 Advised strategies	28
3.7.1 Diving in darkness	28
3.7.2 Decompression	28
Section 4: Setup	31
4.1 Editor use	31
4.2 Decompression	32

Section 9: Apps	51
9.1 Analyzer	51
9.1.1 Measuring	51
9.1.2 Calibration	51
9.2 Games	51
9.2.1 Sokoban	52
9.2.2 Snake	52
Section 10: Hardware	53
10.1 Charging	53
10.1.1 Powering in hyperbaric environment	53
10.2 Wrist mount	53
10.3 Control elements	54
10.4 Physical dimensions	55
10.5 O ₂ sensor cable	56
10.6 Environmental specifications	57
10.7 Compliance	57
10.7.1 CE marking	57
10.7.2 EN 13319	57
10.7.3 FCC compliance	57
10.7.4 Industry Canada (IC) Compliance Notice	57
10.8 Disposal of waste equipment	58

Section 1: Quick start guide

1. Recharge battery

Use the charger that you find in the package or another suitable USB charger or a computer USB port. See [Charging](#) (page 53) for detailed information.

2. Switch on

Hold both buttons until you feel a vibration and the display starts. The computer will be in surface mode in a few seconds.

3. Reset to factory defaults if necessary

It is not necessary to reset a new computer. If you are in doubt about the correct setting, perform the reset to factory default.

Shortly press both buttons to enter the menu. Move the cursor to Setup with the lower button and select with the upper button. Then move the cursor to Factory defaults, select and confirm. Horizontal calibration starts automatically after the reset. Place the computer on a table and press any key.

4. Adjust to right hand if required

Adjust display orientation to your preference. Shortly press both buttons to enter the menu. Move the cursor to Setup with the lower button and select with the upper button. Then select Preferences → Display → Orientation.

5. Switch to imperial units if required

Adjust the units to your preference. Shortly press both buttons to enter the menu. Move the cursor to Setup with the lower button and select with the upper button. Then select Preferences → User interface → Units.

6. Select wrist mount

If you prefer a strap, attach the strap to the computer. If you prefer a bungee, then remove the screws holding the bars and pass the bungee through the threaded holes.

See [Wrist mount](#) (page 53) for detailed information.

7. Switch to dive mode

In the menu select Dive → Default (OC). A brief overview of settings will appear. Verify settings and confirm with the lower button.

Now your Divesoft Freedom is prepared for simple dive with open circuit SCUBA using air.

Section 2: Operation

2.1 Control elements

For technical specification of inputs see [Control elements](#) (page 54) in the Hardware section.

2.1.1 Meanings of inputs in surface modes

The keys and other inputs are assigned meanings in connection with the current navigation item in the menu. At the same time, however, general rules, which apply wherever possible, are determined for their use.

Press upper key – confirm the menu item just selected

Press lower key – cycle downward through the menu

Press both keys – exit the menu without performing any action

Long press upper key – page up

Long press lower key – page down

Long press both keys – return to main screen

Coded key press (press both keys, then release one key and press it again, then release both keys) – enter service functions menu

Tilt away from yourself – increase of the entered digit by one or check flag

Tilt toward yourself – decrease of the entered digit by one or uncheck flag

Tilt to the left – move the cursor to the left

Tilt to the right – move the cursor to the right

Wherever possible (menu, editing screen), helpful symbols relating to the keys are displayed. A symbol can be either next to a key, indicating the action executed during a short key press, or between the keys, indicating the action executed during a short press of both keys.

The  symbol next to a key means move down one row in the menu. Moving in the menu is cyclical, so the first row appears again after the last row. The move-up function is not available.

The  symbol means return one level without executing any action.

The  symbol represents confirmation of the action or selection.

2.1.2 Meanings of inputs in dive modes

The meanings of inputs are the same as in surface modes. Other possibilities are:

Long press upper key – gas switch shortcut (previous mixture)

Long press lower key – gas switch shortcut (next mixture)

Tilting is expanded with movement in games; otherwise, entry of digits, for which tilting is used in surface modes, is limited during the dive to only special cases.

Tapping on the display glass – switch on the display if it is switched off.

Shining a light on the display – in the dark, illuminating the display with a dive light activates it similarly as when tapping on the glass. In the light, the display can be activated by covering and then uncovering it.

2.1.3 Language

All textual information on the Divesoft Freedom is in English. Controlling the apparatus requires knowledge of the English language minimally at a level that allows the user to thoroughly understand this information.

2.2 Brightness control

The 3 levels of the display backlight brightness can be switched by the lower key; the display off, the level set in the Setup → Preferences → Display → Brightness and the maximum brightness (equivalent to level 9).

If the display is off, then use the short press to switch it on. The second and subsequent press with a short delay between presses (< 1 s) switches the brightness level.

The display can't shine through disturbed silt or mud on low brightness. If it is necessary to switch to the maximal brightness just short press the lower key repeatedly. The maximum brightness will be set after two button pushes (if the display was off in the beginning) or three pushes (if the display was on).

See also Advised strategies – [Diving in darkness](#) (page 28).

This way of brightness control works in all modes except gauge and free mode, where lower button is assigned to stopwatch.

2.3 Switching on the unit

The device is switched on by pressing both keys for three seconds.

Automatic activation occurs in the event of entering the water in standby mode. If submerged to a depth greater than 1.5 m, the computer switches to default mode (OC in the default setting, can be changed in Setup → Preferences).

Automatic activation is not immediate, it is necessary to wait a few seconds. The computer may be switched on automatically in higher depth if a descent is rapid. It does not affect the decompression calculation but the first few seconds of the dive profile record will be lost.

The automatic activation on submersion is disabled when switched to the flight mode.

In case the diver forgets to switch on the computer after a flight the computer will switch on at 5 m depth within 1 minute.

2.4 Switching off the unit

Enter the menu from surface mode, select Switch off and Standby mode in the second menu.

Or you can select Flight mode in the second menu. This prevents an automatic activation due to a rapid pressure change and confusion of the surface level detection algorithm.

You can switch off directly from dive mode while on the surface. This way the unit will be switched to standby mode, so automatic activation by submersion is enabled.

The other way to switch off is by waiting for a timeout.



Upon surfacing the Freedom will switch to surface mode after time set in the dive termination timeout. Then it will switch to standby mode after time set in the surface idle timeout. Pushing any button restarts the idle timer in the surface mode.

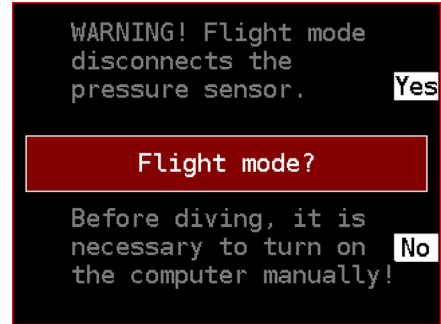

Section 3: Diving

3.1 Surface mode

The surface mode is indicated by the gray table gridlines.

3.1.1 Entering surface mode

The Divesoft Freedom switches to surface mode upon being switched on.

3.1.2 Surface mode screen

Date and Time

Maintain correct local time setting. It will be used for log recording.

Surface time

The time from a previous dive. If it was 99 days ago or more, then FREEDOM banner appears instead of the time.

Default mode

The dive mode, to which the Freedom will be switched if submerged to a depth greater than 1.5 m.

No fly

The calculation of the no fly time is based on the maximum allowed altitude according to the Bühlmann's decompression algorithm ZHL.

The air pressure in the cabin of a commercial aircraft is maintained at a level corresponding to air pressure at 1800–2400 m (6000–8000 feet) above sea level while cruising altitude falls in the range 11 000–12 200 m (36 000–40 000 feet).

The no fly time calculation uses the decisive altitude 4464 m (14 646 ft). At this altitude compartments containing the oxygen masks will be opened automatically and the oxygen masks will drop down in front of the aircraft passengers.







Max altitude

The maximum allowed altitude calculation is based on the ZHL decompression algorithm with an additional safety margin (GF = 0.80).



Battery symbol

A graphical indication of remaining battery capacity. The estimated capacity of full battery is about 10 hours.

-  The battery is full
-  More than half capacity
-  Less than half, but more than quarter capacity
-  Less than quarter capacity
-  Charging is in progress
-  The battery is full, but plugged to a charger

For detailed information see the battery screen in the system check.

3.1.3 Switching to other modes

In the menu → Dive, the user can switch from surface mode to open circuit, rebreather, gauge and freediving modes.

A dive mode cannot start while the Divesoft Freedom is connected to USB port or charger. See also [Powering in hyperbaric environment](#) (page 53).

The Freedom computer can also be switched to the service menu. See chapter [Service functions](#) (page 48).

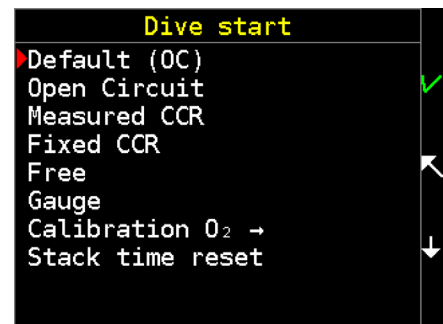

3.2 Open Circuit

The open circuit mode is indicated by the blue table gridlines.

3.2.1 Entering open circuit mode

Open circuit mode can be entered from the menu in surface mode, by automatic activation after submersion (if set as the default mode) or as a bailout from CCR mode (the Close Circuit version only).

3.2.2 Detailed screen

The primary screen displays all necessary information during a dive.

Depth

The depth can be read in the units set in the setup (m or ft). Depth is calculated from measured hydrostatic pressure. Fresh water (default) or seawater density can be set for the depth calculation.

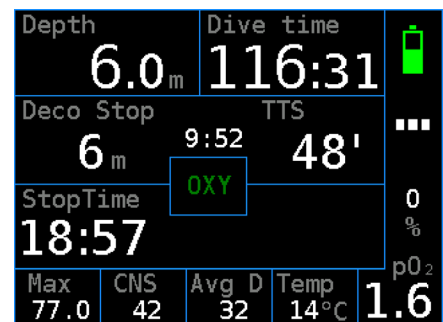

Setting of fresh/sea water doesn't affect decompression calculations. Decompression is based on ambient pressure and is independent of displayed depth. Only depth of decompression stops is rounded up to usual values according to settings of fresh/sea water and metric/imperial units.

Dive time

The timer starts after submersion (depth > 1.5 m) and halts after surfacing (depth < 0.5 m). In case of stay on the surface (or at very shallow depth) followed by a second submersion (during a time set in the dive termination timeout) the dive time indicated will be the time from the first submersion including the surface time.

Deco Stop

The depth of the decompression stop can be read in the units set in the setup (m or ft). Last stop depth depends on settings.

The Deco Stop value is shown only if the stops decompression regimen is set. See Setup → Decompression → [Deco stops](#) (page 33).

Stop Time

Length of the decompression stop at the Deco Stop depth. While on stop, there is a countdown timer here. Rounding of the decompression stop length depends on setting.

The Stop Time value is shown only if the stops decompression regimen is set. See Setup → Decompression → [Deco stops](#) (page 33).

TTS

The time to surface (TTS) includes the complete decompression profile. If *optimal gas* is selected in the decompression settings, then the TTS considers changing of gases from the list of active mixtures; the gas switch time is included.

If the *current gas* setting is selected in the decompression settings, then only the actual gas is used for a TTS calculation.

Ceiling

The ceiling value is shown only if the ceiling decompression regimen is set. See Setup → Decompression → [Deco stops](#) (page 33).

The depth of the decompression ceiling decreases continuously up to the surface. The reading is not artificially stopped anywhere during the ascent. Always stay below the depth of the ceiling, even if the ceiling depth is very shallow.

Ascent above the ceiling generates a warning. Further violation, more than 1 m (3 ft), leads to an additional alarm. Both alarms are logged. The Freedom will continue in open circuit dive mode. It will not switch to a gauge mode or even an SOS mode. Diver should make responsible decision in order to minimize the probability of severe consequences.

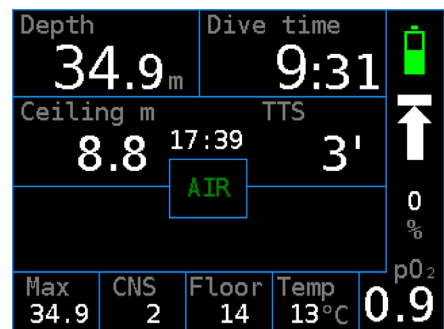

No deco

You can stay for the indicated time at the current depth, breathing the current mixture, to avoid a decompression obligation.

SafetySt

Length of the safety stop is 3 min. The safety stop can be carried out within depth from 6 to 3 m (20 to 10 ft). The safety stop is indicated if the maximum depth of a dive was greater than 10 m (30 ft).

Countdown of the safety stop is interrupted at depths greater than 6 m. Descent to depths greater than 10 m resets the time of the safety stop back to 3 min.

A violation of the 3 m ceiling is logged (silently). Ascent above 1.8 m generates an alarm and leads to the end of the safety stop regimen for a current dive.

The safety stop can be switched off. See Setup → Decompression → [Safety stop \[On\]](#) (page 32).

DeepStop

The depth of the upcoming deep stop is based on Richard Pyle's algorithm. A timer countdown starts here after arriving to the displayed deep stop depth.

Violation of the deep stop is logged but no alarm is generated because deep stops are considered as an additional safety factor only.

These Pyle deep stops are shown only if switched on. See Setup → Decompression → [Deep stops](#) (page 33).

Local Time

The local time is shown on the display directly above the mixture indication.

Mixture

The center of the display indicates the current gas mixture.

Warning: If the breathing mixture is not identical to the indicated mixture, then the calculated decompression profile will be wrong and may be dangerous to follow. In that case you must use a backup method of the decompression profile calculation.

Max

This shows the maximum depth reached during a dive.

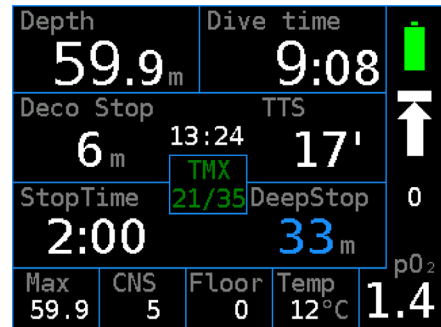

CNS

Exposure to high oxygen partial pressure may under certain circumstances cause acute (CNS) oxygen poisoning. This may cause the affected person to drown.

The so called “oxygen clock” is a percentage of consumption of CNS toxicity limit. Calculation is based on NOAA oxygen exposure limits.

pO ₂ (bar)	Maximum Single Exposure (minutes)	Maximum per 24 hr (minutes)
1.60	45	150
1.55	83	165
1.50	120	180
1.45	135	180
1.40	150	180
1.35	165	195
1.30	180	210
1.25	195	225
1.20	210	240
1.10	240	270
1.00	300	300
0.90	360	360
0.80	450	450
0.70	570	570
0.60	720	720

CNS oxygen clock value does not take chronic (pulmonary) oxygen poisoning into account. For exposures common to technical diving, chronic toxicity manifestations are not significant. For very long dives it is necessary to calculate with long-term exposure limits and to limit the overall exposure.

When pO₂ ≥ 1.4 bar then the CNS toxicity limit is always shorter than the pulmonary toxicity limit.

For calculations related to chronic toxicity use the REPEX method that you know from the nitrox diving course. The Divesoft Freedom does not perform calculations associated with chronic oxygen toxicity.

Avg D

Average depth. It is possible to create a new start point for depth averaging; in dive menu select Settings → Reset average.

Floor

Decompression floor is the depth at which the time to surface (TTS) does not increase.

Calculation of the decompression floor is approximate. Staying at the exact depth of the indicated floor leads to a modest decrease in the upcoming decompression time.

This position on the detailed screen is customizable. You can alter the decompression floor or average depth in Setup → Preferences → Display → Custom fields.

Temp

Water temperature is measured inside the computer case. After temperature change wait about 1–2 minutes until the temperature reading reaches a stable value. The temperature in air is affected by many factors and is only an indication.







A temperature correction can be set in Setup → Calibration for better accuracy.

pO₂

The calculation is based on depth and O₂ fraction in breathing mixture.

Combined graphic symbol

The combined graphic symbol on the detailed screen is intended for rapid orientation. It tells the diver what must be done. The color of the warning symbols changes from yellow to red according to the degree of importance.

-  Permitted to ascend to the surface.
-  Permitted to ascend to the depth of the decompression stop or decompression ceiling.
-  The depth of the decompression ceiling or decompression stop has been reached; do not change depth.
-  The depth of the safety stop has been reached; do not change depth.
-  The ascent rate has been exceeded; slow down your ascent.
-  The current depth is less than the depth of the decompression ceiling; descend.

Vertical speed

There is an indication of the ascent or descent rate below the combined graphical symbol. Can be set to a relative (%) or absolute (m/min or ft/min) reading. The relative reading is based on the maximum ascent or descent rate. See Setup → Preferences → User interface → Vertical speed.

Battery symbol

A graphical indication of the remaining battery capacity. See chapter Surface mode – [Battery symbol](#) (page 13).

3.2.3 Synoptic screen

The depth value is easy to read. It is accompanied by other important information.

The meaning of all values is identical to the detailed screen.

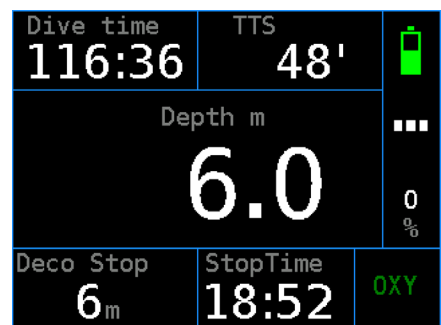

3.2.4 Big Screen

The most important information is written in really big characters.

This screen is useful in very bad visibility. Many divers can read numbers even without a mask.

The meaning of all values is identical to the detailed screen.



3.2.5 Dive profile screen

Start

The time of submersion is useful for checking compliance with the schedule.

Avg

The average depth is indicated with the yellow horizontal line and with the average depth displayed in yellow.

A new start point for depth averaging can be created (in dive menu select Settings → Reset average). This point is indicated by the yellow vertical line and the horizontal average depth line starts from there.

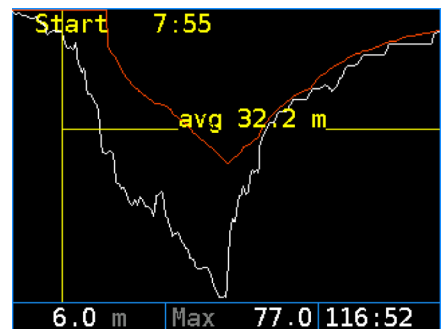
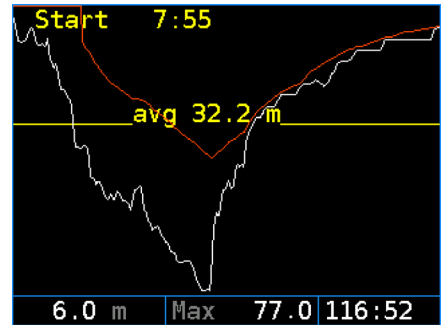

Current depth

See lower left corner.

Dive time

Runtime of current dive is placed in lower right corner.

Max

Maximum depth reached during the dive. Field with this value is placed in the middle of bottom line.

3.2.6 Dive menu

During a dive, in any dive mode, press both keys simultaneously to show the dive menu.

There is current depth, partial pressure of oxygen and dive time on the bottom of the screen.

Mix

Mixture selection. Only active mixtures are listed and can be selected.

Mixtures with pO_2 outside breathable range are displayed in red (if pO_2 is too high) or blue (if pO_2 is too low). This does not prevent selection of this mixture. An alarm will be activated after this kind of switch.

Limits of breathable range are set in Setup → Mixtures.

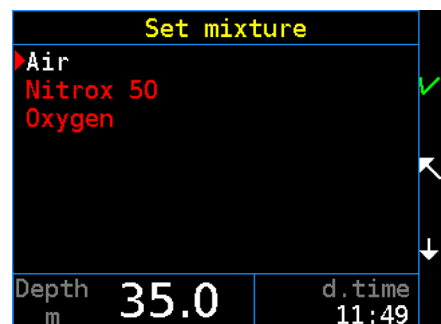
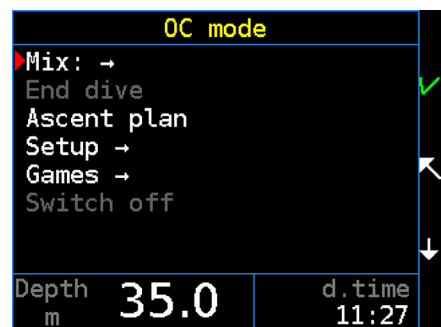

End dive

End dive and switch to surface mode. This menu item is enabled only on the surface (at depth < 0.5 m).

Ascent plan

By default the plan includes all gas switches during the decompression, including gas switch stop duration. If ascent gas is set to current in decompression setting, then no gas switches are included in the plan.

Ascent plan 1/1			
Dpt[m]	Time	RunT	Gas
21	2'	24'	EAN 50
12	1'	26'	EAN 50
9	3'	30'	EAN 50
6	4'	35'	Oxygen
3	8'	44'	Oxygen
Sum	20'	45'	

Depth m	59.9	d.time 19:07
------------	------	-----------------

Setup – Bailout GF

Switch to gradient factor pair for bailout (BoGF) and vice versa. You can switch between standard and bailout GF anytime during a dive.

See also Setup → Decompression → [Gradient factor](#) (page 32).

Setup – Reset average

It restarts calculation of average depth. The restart point is indicated by the vertical line on the dive profile screen.

Setup	
Bailout GF	
Reset average	✓
Mixture setup →	
Display →	
Force dive end	

Depth m	35.0	d.time 12:12
------------	------	-----------------

Setup – Mixture setup

Corresponds to mixture setup in Setup → Mixtures → Mixture setup.

This feature is intended only for emergency situations. Do not use this setup on a regular basis.

Setup – Display

This setting corresponds to Setup → Preferences → Display.

Setup – Force dive end

If the surface pressure (zero depth) was incorrectly detected and the computer “dives” while on the surface then the dive can be forced to stop with this function.

Warning: Do not force dive end underwater!

Games

Simple games can be played during a dive, especially during decompression. See [Games](#) (page 51).

Switch off

End dive and switch directly to the standby mode. This menu item is enabled only on the surface.

3.2.7 Gas switch shortcut

Long press of the upper key selects previous gas mixture. Long press of the lower key selects next gas mixture. This list is cyclic.

What mixtures can be switched depends on the setting in Setup → Preferences → User interface. The default setting for gas shortcuts is off.

If Breathable is selected, then mixes with pO_2 inside the breathable range with regard to the current depth are switched. The limits of the breathable range are set in Setup → Mixtures.

If All is selected, then all active gas mixes are switched, regardless of breathability. An alarm could be activated after this kind of switch. The computer will wait five seconds before generating an alarm. The user can choose the correct gas mixture during this interval.

3.3 Fixed setpoint CCR

The rebreather dive modes are only available in the Closed Circuit version of the Divesoft Freedom.

It is strongly recommended to familiarize yourself with open circuit (OC) diving using the Divesoft Freedom before using for rebreather diving. This chapter of User manual describes only the differences from OC diving. First you will have to study the OC mode.

If the Freedom is used as a backup computer for an eCCR then the proper setting corresponding to the setting of the eCCR electronic is crucial. If a manual CCR (mCCR) is used then maintain the pO₂ in the breathing loop on the value equivalent to the Freedom setpoint (SP). If a SCR is used then select the correct type of SCR and adjust its parameters in setup.

See Setup → [CCR/SCR Setup](#) (page 37).

Don't forget to set up the OC bailout too, especially the default mix.

The fixed setpoint CCR mode is indicated by the cyan table gridlines.

3.3.1 Pre-dive and submersion

Switch the Freedom on before entering a water. Check the Freedom settings as part of a pre-dive check.

The first screen is a summary of the decompression settings and the OC (bailout) parameters, the second screen is the summary of rebreather specific parameters.

If submersion to a depth greater than 1.5 m occurs, the computer switches to the default mode. Set default mode to the CCR fixed during dive preparation in Setup → Preferences. Do not intentionally use this switching method; it is intended only for emergency situations.

3.3.2 Setpoint

The SP low is set after switching to the fixed setpoint CCR dive mode on the surface. It can be switched to the SP high manually (via the shortcut or via the menu) or automatically at a set depth during a descent or at a set runtime.

SP reading (eCCR)

The current setpoint value is located where the pO₂ is situated on the display in OC dive mode on both the detailed and synoptic screen.

pO₂ reading (SCR)

The calculated pO₂ value is shown instead of the setpoint if you dive with the SCR. See [CCR/SCR Setup](#) (page 37).

Shortcut

With the CCR the long press of the upper key selects the high setpoint. The long press of the lower key selects the low setpoint. The shortcut is by default off but it can be enabled in Setup → Preferences → User interface (set All or Breathable, as you prefer for open circuit).

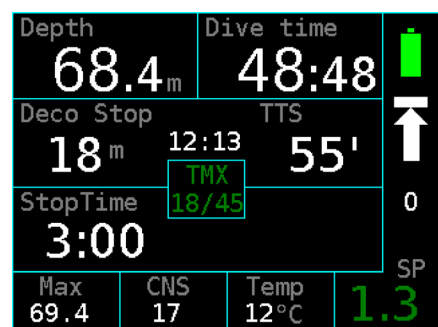
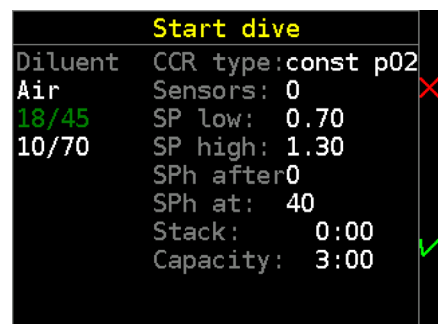
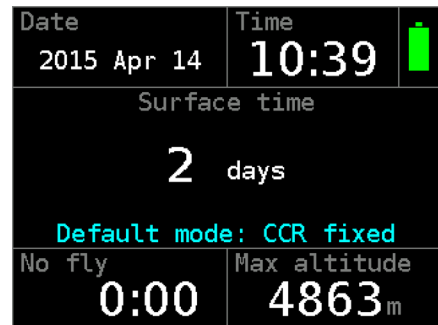

If the semi-closed rebreather (SCR) is used, then the gas mixture is switched with this shortcut (similar to OC mode).

Manual SP setting

Select Setpoint from the dive menu.

The high and low setpoint can be chosen directly from the menu. For the current setpoint adjustment use the +0.10 and -0.10 menu items for the SP value change (can be used repeatedly; the final value is displayed) and then select Accept for the change.

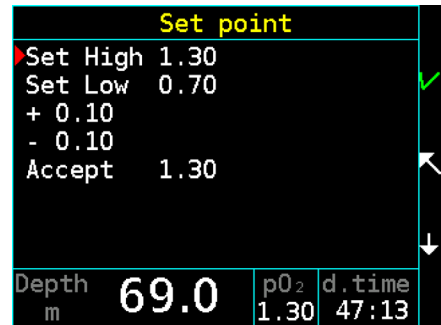

3.3.3 Dive menu

Bailout mode (OC)

It is assumed that the diver will not breathe from the rebreather’s breathing loop but will rather use a separate open-circuit bailout apparatus.

After switching to the bailout OC mode, the default OC mixture will be used and the safety level will be automatically set using the bailout gradient factors. The BoGF tag appears on the detailed and synoptic screen.

It is possible to switch between the standard and bailout GF sets in the menu without affecting the mode in which the Freedom is operating.

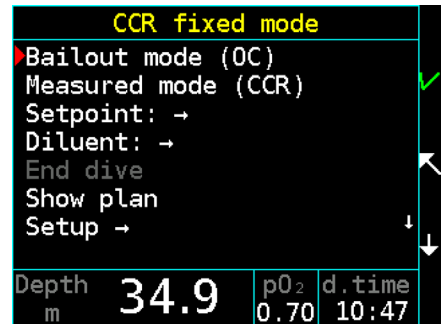

Measured mode (CCR)

Use for switching to rebreather dive mode with the measured pO₂. See next chapter.

Setpoint

Use to switch the low/high setpoint and the manual setting of the setpoint of the CCR. See the Setpoint chapter on previous page.

Mix

Use for gas mixture switching for SCR. This is similar to the OC mixture selection.

Diluent

Use this menu item for the diluent gas switch.

Setup – Diluents

This (the CCR only) menu item corresponds to the mixture setup in Setup → SCR/CCR Setup → Const CCR setup → Diluents.

Setup – Mixture setup

This (the SCR only) menu item corresponds to the OC mixture setup in Setup → Mixtures → Mixture setup.

3.3.4 Stack time

The scrubber stack timer runs all the time in any rebreather mode regardless of depth, even on the surface.

If you spend a long time in dive mode while not breathing from the rebreather’s loop, then increase the time for the stack time warning.

Don’t forget to reset the timer when you refill the scrubber (Dive → Stack time reset).

You can find the stack time on the O₂ sensors screen.

Day time: 13:57:52	
67.9 mV	1.30 bar
70.0 mV	1.30 bar
62.2 mV	1.30 bar
Stack time:	25:07

3.4 Measured CCR

The rebreather dive modes are available in the Closed Circuit version of the Divesoft Freedom only.

This chapter of the user manual describes only the differences from the fixed setpoint CCR diving. First you will have to study OC mode and fixed setpoint CCR mode.

3.4.1 O₂ sensors connection

The measured CCR dive mode requires a connection to the O₂ sensors of a rebreather. One, two or three sensors can be connected.

The cable equipped with the Molex connectors is included in the Closed Circuit version of the Divesoft Freedom distribution package or can be ordered separately. See also [O₂ sensor cable](#) (page 56).



3.4.2 O₂ sensors calibration

If possible, use oxygen with purity of at least 99.5% for calibration.

Do not use air for calibration. The partial pressure of oxygen in air at atmospheric pressure significantly differs from the partial pressures determined by the setpoints. At the end of its service life, an oxygen sensor can successfully undergo calibration to 21% (air), but will no longer be capable of measuring pO₂ of 1 bar or higher.

Procedure:

1. Dive → Calibration O₂ → Start calibration
2. Check the calibration gas
3. Wait for stable values
4. Start and wait for calibration process to end
5. Confirm the save

Whether or not a sensor is already at the end of its service life is also determined during calibration.

At higher altitudes above sea level, the partial pressure of oxygen in the calibration mixture decreases in proportion to lower atmospheric pressure. The Freedom measures atmospheric pressure and takes it into account during calibration. Therefore, do not perform any corrections at higher altitudes above sea level.

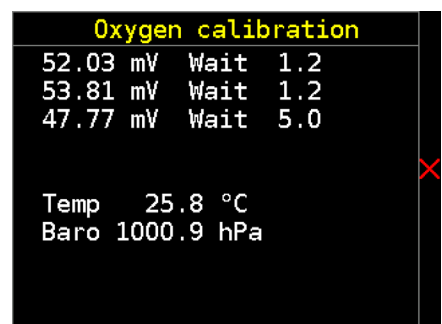
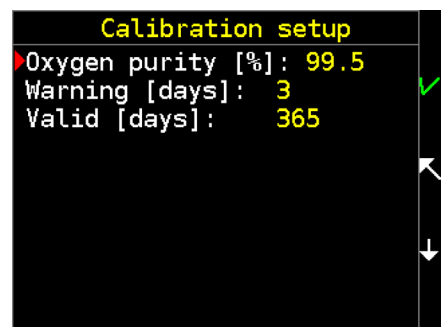
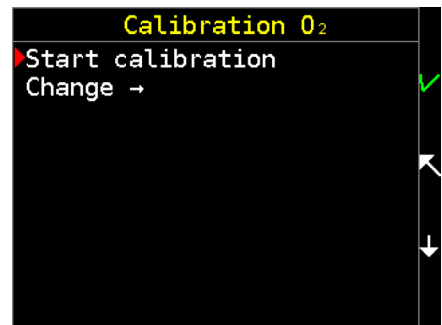

It is preferred to calibrate O₂ sensors prior each dive. Do not use sensor reading from sensors calibrated more than three days ago.

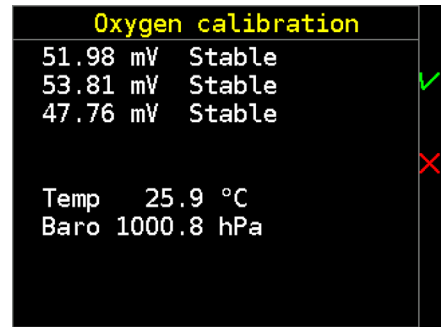

3.4.3 pO₂ reading

There is a separate O₂ sensor screen in both the surface and dive mode.

Not only the pO₂ but also the voltage on sensors can be read. If the state of a sensor is not in operational mode (not connected, error, excluded, disabled, uncalibrated), the appropriate tag appears instead of the pO₂ value.

On the detailed and synoptic screen there is only one reading of the pO₂ value; the arithmetic average of active sensors is used.

You can mark any sensor as faulty during a dive in dive menu Setup → Faulty sensors.

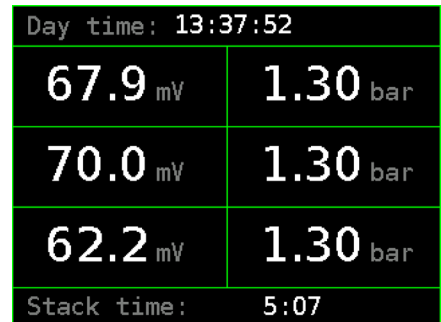
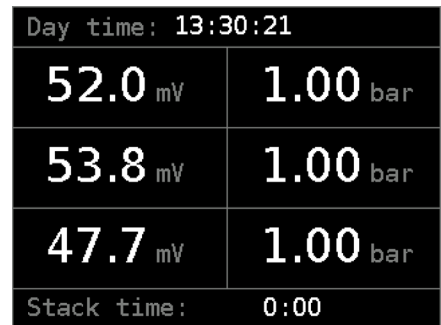

3.5 Gauge

The gauge mode is indicated by the dark red table gridlines.

There are two forms of the gauge mode – with and without rebreather O₂ sensor reading. The rebreather gauge mode is only available in the Closed Circuit version with at least one connected O₂ sensor.

3.5.1 Synoptic screen

Stopwatch

Operate the stopwatch via the menu. See [Stopwatch](#) (page 25).

Battery symbol

A graphical indication shows the remaining battery capacity. See [Battery symbol](#) (page 12).

Dive time

The timer starts after submersion (depth > 1.5 m) and halts after surfacing (depth < 0.5 m). If stay on the surface (or at very shallow depth) is followed by a second submersion (during a time set in the dive termination timeout), then the dive time indicated will be the time from the first submersion including the surface time.

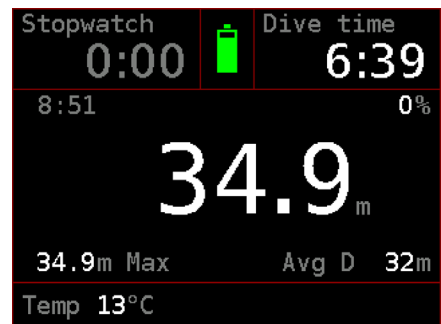

Local Time

The local time is shown on the display in the top left corner of the middle section.

Vertical speed

The ascent and descent rate indication can be set to a relative (%) or absolute (m/min or ft/min) reading. The relative reading is based on the maximum ascent or descent rate. Set in Setup → Preferences → User interface → Vertical speed.

Depth

The depth reading can be set to m or ft in the setup. Depth is calculated from measured hydrostatic pressure. For calculation fresh water (default) or seawater density can be set in Setup → Preferences.

Max Depth

The maximum depth reached during the dive.

Avg depth

The average depth of the dive. A new start point for depth averaging can be created via the dive menu. This point is indicated by the yellow vertical line on the profile screen.

Temp

Water temperature is measured inside the computer case. After a temperature change wait about 1-2 minutes until the temperature reading reaches a stable value. The temperature in air is affected by many factors and is only an indication.

A temperature correction can be set in Setup → Calibration for better accuracy.

3.5.2 Big Screen

The most important information is written in really big characters.

This screen is useful in very bad visibility. Many divers can read the numbers even without a mask.

The meaning of all values is identical to the synoptic screen.



3.5.3 Dive profile screen

Start

The time of submersion is useful for checking compliance with the schedule.

Avg

The average depth is indicated in yellow by a horizontal line and a numerical value.

A new start point for depth averaging can be created in the dive menu. This point is indicated by the yellow vertical line and the horizontal average depth line starts from there.

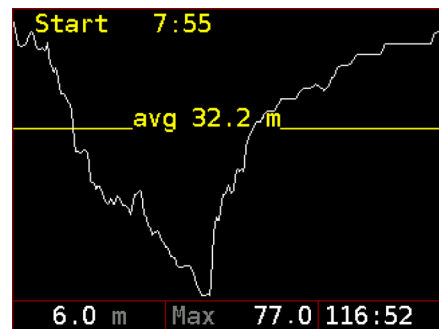

Current depth

See lower left corner.

Dive time

The runtime of the current dive is placed in lower right corner.

Max

The maximum depth reached during the dive. The field with this value is placed in the middle of bottom line.

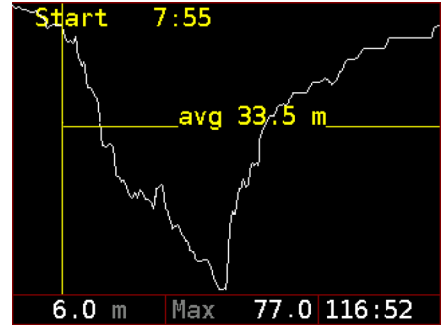

3.5.4 Dive menu

During a dive, in any dive mode, press both keys simultaneously to show the dive menu.

This shows current depth, partial pressure of oxygen (rebreather only) and dive time on the bottom of the screen.

Stopwatch

The elapsed time is written in white while the stopwatch is running or in gray when the stopwatch is not running.

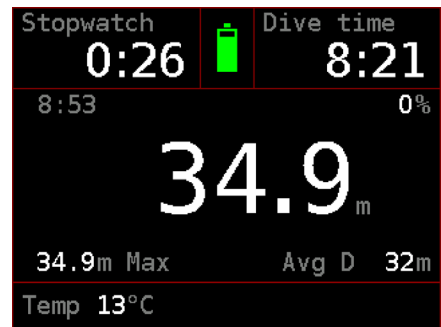

Start stopwatch

This starts the timer.

If the stopwatch was previously halted then the count continues from the indicated time.

Stop stopwatch

This stops the timer, leaving the elapsed time displayed in gray.

Restart stopwatch

This restarts the timer from zero.

This function is especially useful for decompression stops.

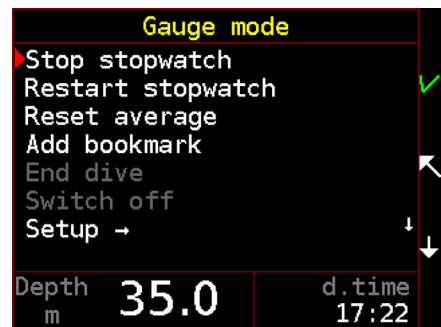
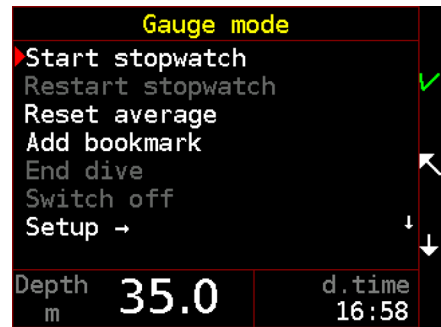

Reset average

A new start point for depth averaging will be created. The restart point is indicated by the vertical line on the dive profile screen.

Add bookmark

A bookmark will be created in the dive log. The bookmark number is displayed in the notification that follows.

End dive

End dive and switch to surface mode. This menu item is enabled only on the surface.

Switch off

End dive and switch directly to standby mode. This menu item is enabled only on the surface.

Setup

Brightness

The display backlight brightness level can be set from 1 to 9. The change in brightness is immediately reflected while adjusting.

Orientation

The left hand, right hand and auto orientation can be selected.

Auto orientation selects the left or right hand position automatically during the start. It will not switch the display orientation when the diver changes position (i.e. during a head down descent).

Screens

Any of the dive mode screen can be disabled.



Games

You can pass the time on a decompression stop with playing games.

See [Games](#) (page 51).

3.6 Free

The freediving mode is indicated by the yellow table gridlines.

3.6.1 Surface screen

The freediving surface screen is shown during a freediving session while on the surface.

Time

The local time is shown on the display in the top left corner.

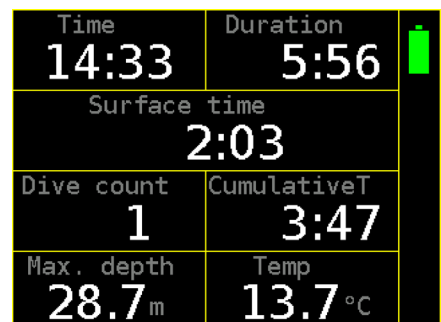

Duration

The timer starts after entering the Free mode. Duration of a freediving session includes the time on the surface and the time spent underwater.

Surface time

This timer is triggered by surfacing.

Dive count

Number of dives during a freediving session.

CumulativeT

The cumulative time is the sum of the time spent underwater.

Max. depth

This is the maximum depth reached during a freediving session.

Temp

Water temperature is measured inside the computer case. After temperature change wait about 1-2 minutes until the temperature reading reaches a stable value. The temperature in air is affected by many factors and is only an indication.

A temperature correction can be set in Setup → Calibration for better accuracy.

3.6.2 Dive screen

The freediving dive screen is shown during a dive (after the descent to the On depth and before the ascent above Off depth). Both depths can be set in Setup → Freediving.

The dive screen with the maximum depth and the dive time of the last dive is accessible after surfacing with a short press of the upper button from the surface screen.

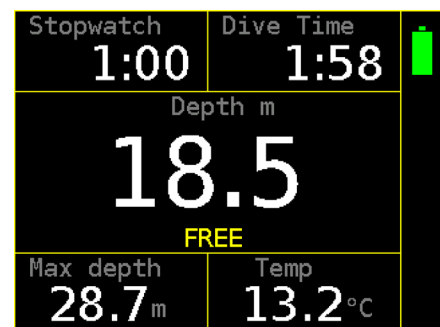

Stopwatch

Operate the stopwatch by the lower button:

Short press: start/stop

Long press: reset

Dive time

The timer starts after submersion to the On depth and stops after ascending above the Off depth.

Depth

The depth can be read in the units set in the setup (m or ft). Depth is calculated from measured hydrostatic pressure. For calculation fresh water (default) or seawater density can be set.

Max Depth

The maximum depth reached during the dive.

Temp

Water temperature is measured inside the computer case. Because the system is slow, it provides only an indication during short dives.

3.7 Advised strategies

3.7.1 Diving in darkness

High brightness all the time

This is the preferred option for a simple dive with a high power diving light (torch) used by all team members. Brightness level 6 to 8 is recommended.

Don't use this option if light coming from the Freedom display and light coming from your diving partner's torch can't be clearly distinguished in the peripheral vision. Otherwise it may lead to the separation of the team members.

Switching on-off

This option is typical for cave diving. Set brightness to a high level (6 to 9) and a short screensaver timeout (15 s is more than enough).

Preferably activate the display by light during a dive. Move the Freedom to the light beam instead of moving the beam to prevent confusion with a light signal.

Low brightness

For diving with eyes accommodated to darkness use the lowest brightness setting (level 1). Your night vision will not be disturbed. It is preferred to have the display on all the time (i.e. screensaver timeout set to 0). This option is typical for night dives in clear water.

Dive with slightly brighter display while using a low power torch. Balance the power of the backlight to the power of your torch to find the optimal setting – no glare but good readability.

The display can't shine through disturbed silt or mud on low brightness. If it is necessary to switch to maximal brightness just short press the lower key repeatedly.

3.7.2 Decompression

Gradient factors

Experienced divers usually set GF regarding to planned dive profile and after dive activity.

GF low 0.30 is default value suitable for an average healthy diver and dive profiles within recreational range. Lower values are more suitable for deeper dives including extended range air dives and use of helium rich mixtures. 0 is not uncommon. Use lower value if any risk factor is present. Higher value can be used for relatively shallow dives, but influence of GF Low on these dives is small (zero on so called non-decompression dives).

Default GF high 0.80 increases the time at the shallow stops relatively slightly compared to the bare Bühlmann's decompression algorithm ZHL. If any risk factor is present, lower value is more appropriate. This also applies if another dive is planned in a short time or physical activity cannot be avoided shortly after the dive. Low value of GF high also shortens so called no-deco limits. GF high 0.50 can be considered as very conservative. For an even smaller value is not usually the reason.

Risk factors

Use a more conservative setting and make only dives with short or no decompression if any risk factor is present.

The major risk factors for decompression sickness (DCS) are:

- Dehydration
- Heart disease, especially PFO (patent foramen ovale) or ASD (atrial septal defect)

- Previous DCS
- Older age
- Overweight or obesity
- Exercise during a dive or post dive
- Fatigue
- Irresponsibility or inability to follow proper decompression procedures

If excessive fatigue or any other subclinical form of DCS occurs after a dive during which a proper decompression was performed then the presence of one or more risk factors can be assumed.

Dividing with air or one nitrox mixture

Confirm the following settings:

- The default OC mix is set to air or nitrox, whichever one you plan to use (Setup → Mixtures)
- All other gas mixtures are disabled (no checkbox checked on the list Setup → Mixtures → Mixture setup)

Warning: if the ascent gas is set to Optimal (Setup → Decompression) **and multiple gas mixtures are enabled then the decompression plan expects their use.** This may lead to indication of shorter time to surface (TTS) and shorter decompression stops. Improper settings like this can't affect the safety of the decompression if you strictly follow the computer; it only affects the calculation of the plan. This is not applicable to the Basic nitrox version of the Freedom.

Multi-day repetitive dives

It is advised to use a slightly more conservative setting for diving holidays. Do not disable or omit the safety stop. Use nitrox if available and if you are qualified.

Remember that the diving computer does not know diver's physical shape. Maintain a high level of hydration during diving holidays. Do not dive drunken or hungover. Do not dive ill.

Long decompression safety

Preferably, control the decompression safety with the GF high setting and disable the safety stop if the decompression obligation is longer than 20 minutes. A smaller value of the GF high setting can be used additionally for increasing safety on the shallow end of decompression, if required.

Switch to bailout gradient factors if you wish to reduce the decompression time (while increasing the risk of DCS). Bailout GF's shall be properly set before dive.

Multiple gas usage

This is not applicable to the Basic nitrox version of the Freedom.

Multiple gas usage requires appropriate qualification from a recognized training agency.

Confirm the following settings:

- The ascent gas is set to *Optimal* (Setup → Decompression)
- All gas mixtures, which you plan to use are properly set and active; and other gas mixtures are inactive (Setup → Mixtures → Mixture setup)
- The default OC mix is set to the gas you plan to descend with (Setup → Mixtures)
- The gas switch time is set to your preferred time (commonly 2 or 3 minutes)

Never switch the computer to another gas before you start breathing it. Make sure that you breathe the right gas with the MOD greater than your current depth.

Extreme deep diving

Every technical diver who dives to depths greater than 100 m/330 ft has to develop his or her own decompression strategy. It is necessary to increase the personal limit gradually, step by step. The maximum operating depth of the Freedom is 300 m/1000 ft. This is probably a much greater depth than you and your body could handle.

For extreme depth, short bottom-time decompression strategies are common:

- Dive only if in really good physical shape; get your heart examined for PFO
- Use the computer only as a backup for the plan based on your previous experience
- Use a very low value of the GF low; 0 is not uncommon
- Use a high value of the GF high; 1 is not uncommon and even >1 is not uncommon (requires the special, personally granted license)
- Use optimal gas mixtures
- Stay in the water for minimum 15 minutes after surfacing
- Avoid post-dive exercise; take advantage of the support team
- Maintain thermal comfort during a dive; avoid a hot shower after the dive
- Avoid diving or any other pressure change in the following 48 h

The Divesoft Freedom is not intended for long bottom-time extreme deep diving in any mode other than the gauge mode.

The Full trimix or the CCR version of the Divesoft Freedom is required for trimix decompression calculation.

Section 4: Setup

The Divesoft Freedom is configured in the surface mode. Activate the surface mode main menu with a short press of both keys and select Setup.

Some values can be set during a dive; however, this possibility is reserved for resolving exceptional and emergency situations.

The particular set values depend primarily on the user’s experience, physiology and personal preferences. The fact that Divesoft Freedom enables setting a certain value does not mean that this kind of setting is safe and suitable for you and for your planned dive.

If you are not sure which value to set, leave the values of the default setting.

The manufacturer does not provide a warranty for faulty operation of the Divesoft Freedom if this kind of faulty operation is the result of an improper setup.

The factory default setting value is shown in square brackets in the following headlines.

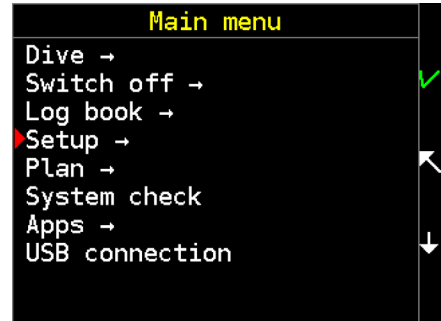

4.1 Editor use

The majority of variable values is edited in a similar manner.

Tilt toward yourself– decrease the entered digit by one or uncheck flag

Tilt to the left – move the cursor to the left

Tilt to the right – move the cursor to the right

Press upper key – discard editing (reset to previous value)

Long press upper key – reset to default value

Press both keys – exit without save

Press lower key – save and exit

Permissible range is indicated by <minimum .. [default] .. maximum> value.

The display shows a brief description below.

Note: Perform the [Horizontal calibration](#) (page 41) if there is no valid response to tilting or tapping.

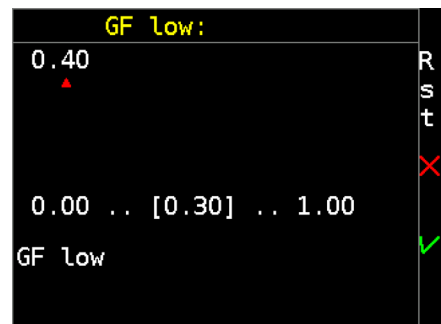

4.2 Decompression

4.2.1 Gradient factor

GF low [0.30]

The gradient factor at the start of decompression (range: 0.00–1.00).

GF low determines an additional increase of safety at the depth of the first decompression stop or, as the case may be, at the depth of the decompression ceiling at the start of decompression. Setting the value of 1.00 corresponds to the Bühlmann decompression algorithm without additional increase of safety using the gradient factors method.

Setting low values leads to deeper and longer stops at the start of decompression.

See also Advised strategies – [Gradient factors](#) (page 28).

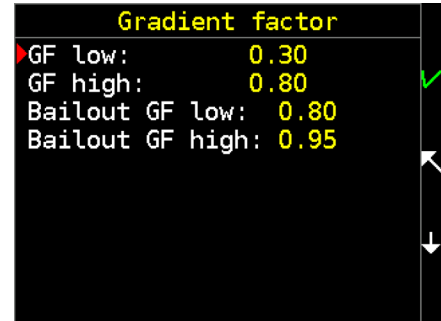

GF high [0.80]

The gradient factor at the end of decompression (range: 0.00–1.00).

GF high determines an additional increase of safety when ascending to the surface. Setting the value of 1.00 corresponds to the Bühlmann decompression algorithm without additional increase of safety using the gradient factors method.

Setting low values leads to prolongation of shallow decompression stops.

For extreme dives a GF high greater than 1 is sometimes used (less safe than the standard Bühlmann decompression algorithm). This requires the special, personally granted license.

See also Advised strategies – [Gradient factors](#) (page 28).

Bailout GF low [0.80]

The gradient factor for bailout at the start of decompression (range: 0.00–1.00).

As a general rule, for bailout GF low a higher GF value (a lower additional increase of safety) is set than for standard GF low.

Bailout GF high [0.95]

The gradient factor for bailout at the end of decompression (range: 0.00–1.00).

As a general rule, for bailout GF high a higher GF value (a lower additional increase of safety) is set than for standard GF high.

4.2.2 Safety stop [0n]

3 minute safety stop within depth 6 to 3 m (20 to 10 ft) is indicated after a dive to a depth greater than 10 m (30 ft).

4.2.3 Ascent gas [Optimal]

Specifies which mixture or set of mixtures will be used for ascent planning.

If optimal gas is selected, then the time to surface (TTS) and the dive plan assume the changing of gases from the list of active mixtures.

If current gas is selected, then only the gas currently breathed is used for TTS calculation and dive planning. This setting is preferred for dives that do not involve changing gas mixtures.

4.2.4 Deco stops

Stops/Ceil. [Stops]

The Divesoft Freedom can be used in the regimen of separate decompression stops or in the regimen with only the decompression ceiling depth indicated.

As a general rule, the stops regimen is more suitable for open water diving and is easy to understand and follow. The ceiling regimen is more suitable for cave and technical diving. The time spent on decompression is slightly shorter if the ceiling regimen is used for continuous decompression. Personal preference is the most important.

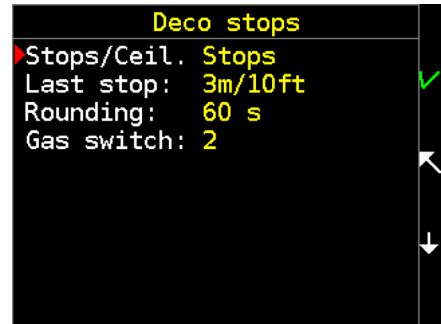

Last stop [3 m/10 ft]

The depth of the shallowest decompression stop can be set to 3 m/10 ft or 6 m/20 ft. Choose the depth according to the conditions on the surface and your preference. A deeper last stop extends the decompression time slightly. Use the 6 m/20 ft last stop when using 100% oxygen for decompression.

Rounding [60 s]

You can choose the time on stop rounding (1s; 30s; 60s).

30 or 60s is a good choice for recreational dives. For deep dives, especially with a small value of the GF low and resulting short stops on decompression start, it is better to choose the 1s rounding. Otherwise a prolonged stay on the deco stop due to rounding may lead to the disappearance of the next short deco stop and could negatively affect the decompression profile smoothness.

Gas switch [2 min]

The gas switch duration may be set from 0 to 5 minutes. This time will be added to the dive plan and TTS calculation.

4.2.5 Deep stops

Pyle Deep stops [Off]

Empiric modification of decompression profile according to Richard Pyle's algorithm.

The combination of Pyle stops and a small value of the GF low can result in a not so optimal decompression profile. Please choose only one preferred method. As a general rule, use GF low 0.30 or less and switch (left switched) Pyle Deep stops Off.

Stops duration [2 min]

The value of the Pyle stops duration (range: 1–3 min).

4.2.6 Ascent rate

Rate is used for calculation of the ascent plan and indication of ascent rate, if relative measuring (percentage) is set in Setup → Preferences → User interface → Vertical speed.

Speed 1 [10 m/min / 33 ft/min]

The anticipated ascent rate within small depths, in zone 1 (range: 1–20 m/min).

The value is m/min in metric and ft/min in imperial units.

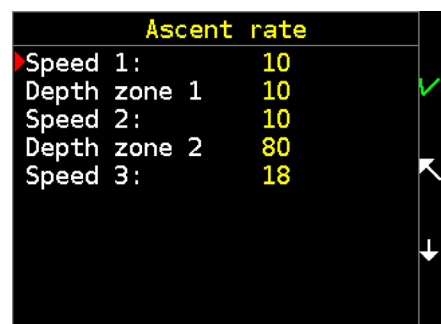

Depth zone 1 [10 m / 3 ft]

The depth defining zone 1. This zone lies between the surface and the set depth (range: 0–300 m).
The value is m in metric and ft in imperial units.

Speed 2 [10 m/min / 33 ft/min]

The anticipated ascent rate within medium depths, in zone 2 (range: 1–20 m/min).

Depth zone 2 [80 m / 262 ft]

The depth defining zone 2. This zone lies between depth zone 1 and the set depth (range: 0–300 m).

Speed 3 [18 m/min / 59 ft/min]

The anticipated ascent rate within large depths, in zone 3. (range: 1–20 m/min).

4.2.7 Descent rate

Rate is used for calculation of the descent plan and indication of descent rate, if relative measuring (percentage) is set in Setup → Preferences → User interface → Vertical speed.



Warn under [80 m]

The threshold at which the alarm is activated to indicate exceeding the descent rate. At smaller depths, exceeding the descent rate is ignored.

The value is in m metric and ft in imperial units.

This alarm is disabled in factory default setting. It can be enabled in Setup → Alarms → Alarm sources → Rates → Descent rate.

Max rate [20 m/min]

The anticipated descent rate (range: 1–40 m/min).

The set rate is also used for dive planning.

The value is m/min in metric and ft/min in imperial units.

Max rate 30 m/min is used to indicate a descent rate at a depth shallower than the warn-under depth.

4.3 Mixtures

4.3.1 Mixture setup

The number of available mixtures depends on the software version.

Basic Nitrox	1 mixture of oxygen and nitrogen, up to 40% of oxygen
Advanced Nitrox	3 mixtures of oxygen and nitrogen, up to 100% of oxygen
Full Trimix	9 mixtures, any content of oxygen, helium and nitrogen
Closed Circuit	9 mixtures for OC, additional 8 diluents in CCR setup

Each mixture can be set as active (marked checkbox) or inactive (clear box). It can be done in the editing screen or by a shortcut – long press of the upper key in the list of mixtures. Only active mixtures can be selected.

The default mixture is always active.

In an emergency, a mixture can be marked as active during a dive. Furthermore, a new mixture can be defined during a dive. These features are reserved for emergency situations.

4.3.2 Def. OC mix

A default mixture for an open circuit apparatus. A different default mixture can only be selected from mixtures that are marked as active.

4.3.3 Min pO₂ [0.18 bar]

The low pO₂ alarm is activated if the current pO₂ is less than the set value (range: 0.18–0.40 bar). The setting of minimum partial pressure of oxygen plays a role in gas switching calculations.

4.3.4 Max pO₂ [1.60 bar]

The high pO₂ alarm is activated if current pO₂ is bigger than set value (range: 0.8–1.6 bar). The setting of maximum partial pressure of oxygen plays role in gas switching calculations.

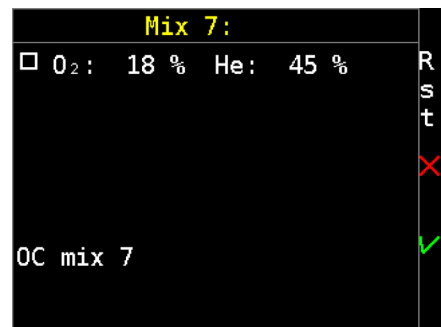
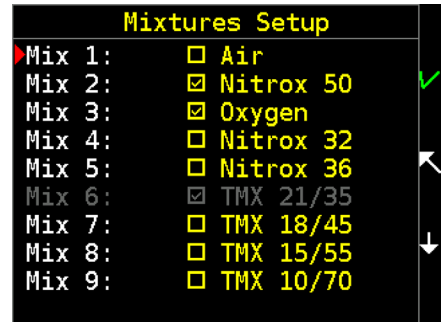
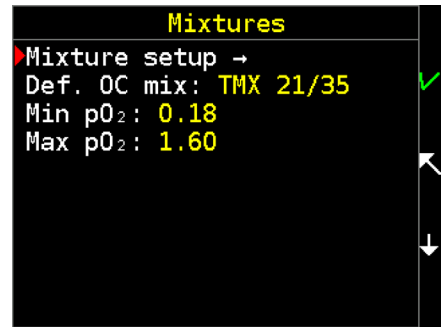

4.4 Alarms

There are two kinds of messages, alarms and notifications. Alarm messages appear on red background, notifications on a blue background.

4.4.1 Global alarms [On]

This allows or prohibits signaling of all alarms for the entire system.

Warning: Global prohibition of alarm signaling is intended only for exceptional cases. If you do not have any serious reason to deactivate the alarms, leave them switched on. If you switch off alarm signaling, you must often check all dive parameters with great care.

4.4.2 Alarm sources

Ceiling [On]

The alarm is activated if the decompression ceiling is exceeded (in the ceiling regimen). In case of violation of more than 1 m (3 ft), the second alarm is generated.

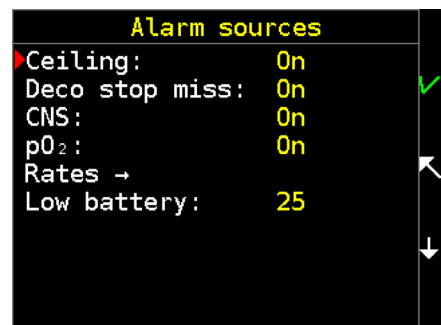
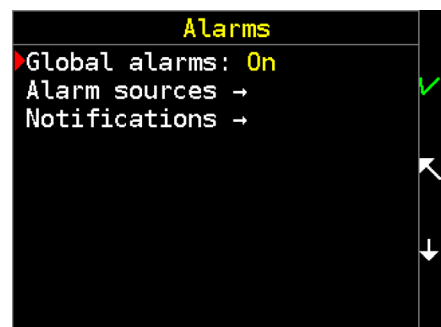

Deco stop miss [On]

The alarm is activated if the decompression stop is violated (in the stops regimen).

CNS [On]

This alarm occurs when 75 %, 90 % and 100 % of CNS oxygen toxicity limit is reached.

pO₂

Occurs when partial pressure of oxygen has exceeded max pO₂ or declined below min pO₂. These limits can be set in Setup → Mixtures.

Rate – Descent rate [Off]

A descent speed greater than set while deeper than set activates the alarm.

See descent rate setting in Setup → [Descent rate](#) (page 34).

Rate – Ascent rate [On]

An ascent speed greater then set for the current deep interval activates the alarm.

See ascent rate setting in Setup → [Ascent rate](#) (page 33).

Low battery [25 %]

The alarm is activated if the remaining battery capacity falls below this limit. Range is 0–40%; 0 means that the alarm is disabled.

If set to a value greater than 10 %, then a second alarm on 10 % occurs.

4.4.3 Notifications

No deco end [On]

The end of the dive in zero time (in the terminology of the Bühlmann decompression model), i.e. notification that there will be a decompression obligation.

Deco stop end [On]

The end of the decompression stop (in the stops regimen). You can ascend to the next stop or to the surface, as indicated on the display.

Gas switch reminder [Off]

A recommendation to switch to a different mix.

Gas switch done [On]

The change of mixture in OC mode or diluent in CCR mode has been executed.

This notification prevents accidental gas mix switch using a shortcut if any key is pressed unintentionally.

Depth

A notification that the set depth during a descent has been reached. It is possible to set three separate depths in the range of 0–300 m, where 0 means deactivation of the notification.

Time

A notification that the dive time has been reached. It is possible to set three separate times in the range of 0–999 min., where 0 means deactivation of the notification.

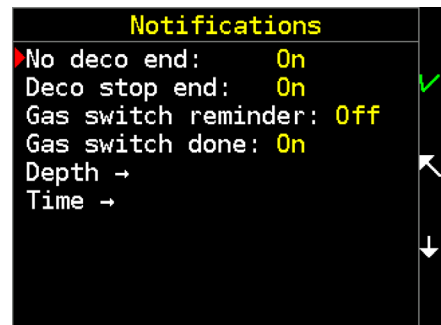

4.5 CCR/SCR Setup

Rebreather settings are available in the Closed Circuit version of the Divesoft Freedom only.

There are four types of rebreather supported:

Measured pO_2

The measured CCR dive mode requires connection to the O_2 sensors of a rebreather.

Const pO_2

Electronic or manual CCR (eCCR or mCCR), where pO_2 is stable regardless of depth change, set by setpoint.

aSCR

The constant mass flow semi closed rebreather (active SCR).

pSCR

Respiratory minute volume keyed semi closed rebreather (passive SCR).

4.5.1 Const pO_2

Diluents

8 mixtures with any content of oxygen, helium and nitrogen can be set. This setting is independent from the OC mixture setting.

The control is the same as with OC mixtures.

Default diluent

A default diluent for a closed circuit rebreather.

SP Low [0.7]

The SP low is set after switching to the fixed setpoint CCR dive mode on the surface.

SP High [1.3]

The SP low can be switched to the SP high manually (via the shortcut or via the menu) or automatically at a set depth during a descent or at a set runtime.

SPhigh auto depth [0 m/ft]

The high will be automatically set after a descent to this depth. Zero disables this feature.

SPhigh auto time [0 min]

The high will be automatically set after the set time. Zero disables this feature.

4.5.2 aSCR

VO_2 [1.5 l/min]

The metabolic consumption of oxygen (VO_2) can be set in the range 0.5–3 l/min.

Constant flow [7.0 l/min]

The constant flow of premix can be set in the range 5–20 l/min.

4.5.3 pSCR

PA ratio [8.0]

The PA ratio can be set in the range 2–16. It is fixed by the design of the SCR.

Ventilatory coef O₂ [20]

The ventilatory coefficient for oxygen is a constant that represents the fact that the harder one works, the faster one breathes (= respiratory minute volume/metabolic consumption of oxygen, VO₂). Fit people have a lower respiratory rate for equivalent amounts of work than unfit people, so the lower value represents a physically fit individual (range: 14–28).

4.5.4 Common settings

Stack time [0 min]

Set the scrubber lifetime. The stack time warning will be generated after this time expires. Zero disables this feature.

Number of sensors [0]

Enter the number of O₂ chemical sensors connected to the Freedom using a cable. One, two or three sensors can be connected.

The cable equipped with the Molex connectors is included in the Closed Circuit version of the Divesoft Freedom distribution package or can be ordered separately.

Faulty sensors

You can mark any connected but untrusted sensor as disabled. By doing so, you will remove these sensors from the calculation of the average pO₂.

4.6 Freediving Setup

On depth [1.0]

The descent to On depth triggers the start of a dive. Set value greater than Off depth.

Off depth [0.3]

The ascent above Off depth means the end of a dive. Set value smaller than On depth.

4.7 Preferences

4.7.1 Display

Orientation [Left hand]

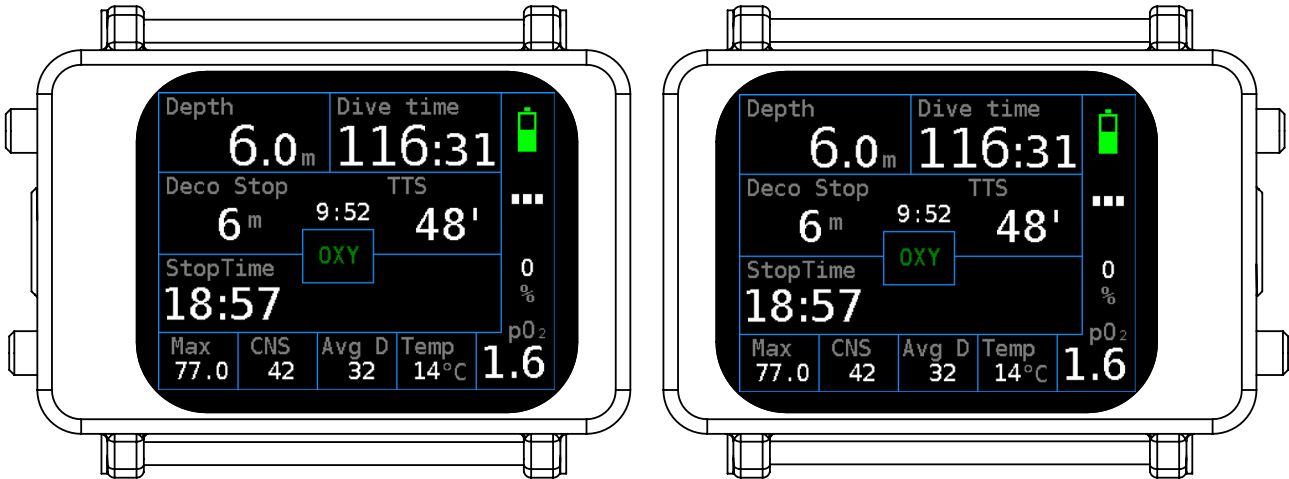

Left hand, right hand and the auto orientation can be selected.

Auto orientation selects the left or right hand position automatically during the start. It will not switch the display orientation when the diver changes position (i.e. during a head down descent).

Brightness

The display backlight brightness level can be set from 1 to 9. The change of brightness is immediately reflected during a setting, so preferably change this setting in the shade or in the dark.

For diving with eyes accommodated to darkness use the lowest brightness setting (level 1). Use high brightness (level 5 to 9) for diving with a high level of ambient light.

Also see advised strategies for [Diving in darkness](#) (page 28).



Screensaver [0 s]

The display will be switched off after the screensaver timeout expires. Zero disables this feature (i.e. display is all the time on).

Show by light [On]

The display can be activated (switched on) with a light beam. The light sensor is on the side of the display adjacent to the buttons, so the light beam has to come from the side opposite the buttons.

Move the Freedom to the light beam instead of moving the beam to prevent confusion with a light signal.

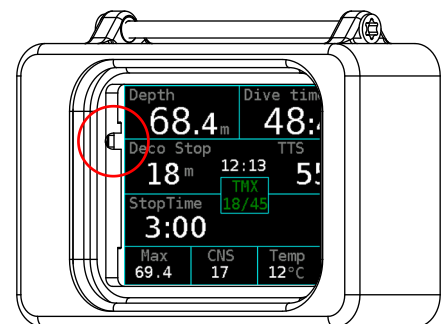

Screens

Any dive mode screen can be disabled.

OC row4/col3 custom field

The decompression floor or the average depth can be set for the detailed OC screen.

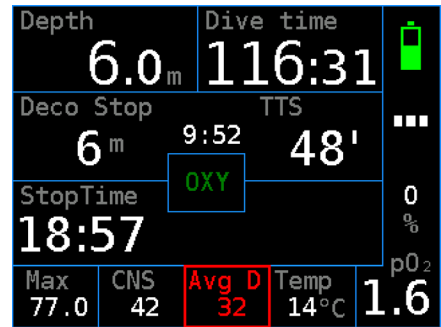

4.7.2 Timeouts

Surface idle [10 min]

The Freedom will be switched off after this timeout expires (range: 1–120 min).

Before switching off, “Shutdown?” question is displayed for 30 s. Select No to restart this timer.

Prepared idle [15 min]

The manually activated dive mode will be switched back to surface mode if the dive does not start during this timeout (range: 1–120 min).

Dive termination [10 min]

The dive will be terminated after surfacing and if no subsequent submersion starts during this timeout (range: 0–30 min). Zero disables this feature (i.e. dive will not be terminated automatically).

Dive end Confirm [Off]

If the dive end confirmation is On then a confirmation dialog is displayed for 30 s before the dive ends. Select No to restart the dive termination timer.

4.7.3 User interface

Units [Metric]

Imperial or metric units can be selected.

Checklist [Enabled]

If this is not disabled then the setting summary will be shown when the dive mode starts.

This is an essential part of a pre-dive check especially for multi-gas and rebreather diving.

Plan order [Time]

The dive ascent plan can be sorted by time or by depth (i.e. in reverse order).

Key press delay [0]

If a greater value than 0 is set then a longer button press is needed to be recognized as valid user input. Use in case of troubles with unintended activation.

Editor navigation [Tilt]

The numbers in the editor can be increased or decreased by tilt or by tap. To control with tapping it is necessary to practice a little. Do not change the tilt setting unless you have a strong reason.

Gas shortcuts [Off]

The default setting for gas shortcuts is off. If enabled then a long press of the upper key selects the previous gas mixture and a long press of the lower key selects the next gas mixture. This list is cyclic.

If the “breathable” option is selected, then mixes with pO_2 inside the breathable range with regard to the current depth are switched. The limits of breathable range are set in Setup → Mixtures.

If the “all” option is selected, then all mixes are switched, regardless breathability. An alarm will be activated after this kind of switch.

Vertical speed [Percent]

If percent is set then the ascent and descent rate are indicated relatively to the ascent and descent speed limits. If unit/min is set then the ascent or descent rate are indicated in depth unit per minute.

4.7.4 Salinity [Fresh]

If changed to the Sea option then the density of seawater will be used for the depth calculation. The majority of depth gauges is calibrated to fresh water. Do not change this setting unless a direct comparison with a depth gauge calibrated to seawater is needed.

Setting of fresh/sea water doesn't affect decompression calculations. Decompression is based on ambient pressure and is independent of displayed depth. Only depth of decompression stops is rounded up to usual values according to settings of fresh/sea water and metric/imperial units.

4.7.5 Default mode [OC]

If submersion to a depth greater than 1.5 m occurs with the computer in surface mode or switched off, the computer switches to the selected default mode.

4.8 Calibration

Calibration O_2

See [O₂ sensors calibration](#) (page 22).

Horizontal calibration

Calibration of accelerometers, which are used for control by tilt or tap. Place the computer horizontally (display up) and press any key. It is preferred to use a steady horizontal ground (e.g. a table).

Pressure corr. [0.00 mbar]

Specify pressure sensor correction for more precise measurement of a barometric pressure or altitude. This correction is not needed for general use.

Temperature corr. [0.0 °C/°F]

Specify temperature sensor correction for more precise measurement of temperature. This correction is not needed for general use.

4.9 Date and time

Local time in format YYYY/MM/DD hh:mm:ss can be set.

Do not change local time between repetitive dives because the change of local time affects the calculation of desaturation during a surface interval.

It is advised to set the local time of a destination prior to leaving for a diving vacation in a different time zone.

4.10 Factory defaults

Reset all setting to default values (except date and time).

Computer will be restarted and the horizontal calibration starts automatically after the reset.

Section 5: Log book

5.1 Last dive

Details from the last dive from list.

Dive profile

The graph is plotted within a white line.

Decompression ceiling

The graph is plotted within a red line; in deco dive only.

Date and time

The time of submersion.

Depth

The maximum depth of the dive.

T

The temperature at its coldest point of the dive (measured during the ascent).

Duration

This indicates time from submersion at the dive start to surfacing at the dive end. It includes all surface stays, if part of the dive. Notice if the decompression obligation was present.

Avg depth

The average depth, calculated from the whole profile.

Mode

Original dive mode (at the dive start).

CNS

The CNS oxygen clock value after surfacing.

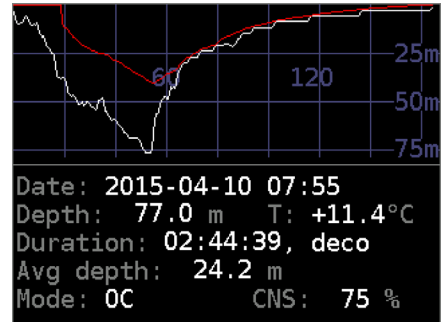

5.2 Dive list

Here all dives from the memory of the Divesoft Freedom are listed. The memory capacity is approximately 100 hours of typical dive profiles. When the memory is full, the oldest records are automatically deleted.

Second and subsequent dives in one day are marked with corresponding letters.

Demo dives (logs stored after the dive simulation) are marked with light blue characters. Test dives are marked with red characters (e.g. the first dive to approx. 350 m).

Use upper button short press to open the screen with the dive details.

Use long press to go through the pages.

Log book - Dive list			
Dive		[min]	[m]
2015-05-17	c	10:22	27.1
2015-05-17	b	41:27	53.2
2015-05-17		31:44	18.8
2015-05-16		71:45	50.2
2015-05-05	c	42:28	32.0
2015-05-05	b	42:01	39.7
2015-05-05		44:01	39.1

Hold to next page

5.3 Summary

A summary of all dives from the memory of the Divesoft Freedom is shown (test and demo dives excluded).

Section 6: Dive planner

6.1 The dive parameters

All non-listed parameters are taken from the respective setting.

Plan mode

Select the dive mode you are planning for.

OC – Open circuit SCUBA

S/CCR – SCR or CCR SCUBA

CCR+BO – SCR descent & bottom followed by OC bailout

Other than OC plan mode is available in the Closed Circuit version only.

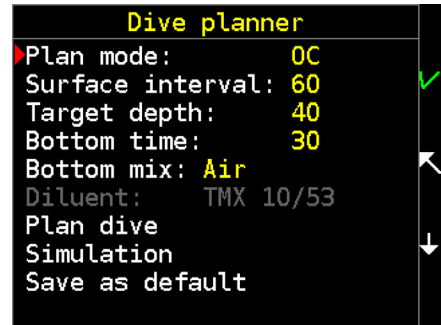

Surface interval

Enter the surface interval from now (in minutes).

Target depth

Enter the bottom depth (in m/ft). For a multilevel dive use an average depth.

Bottom time

Enter the dive runtime when the ascent starts, including descent.

Bottom mix

The gas mixture planned for a descent and the stay on the bottom.

Diluent

Diluent for the SCR/CCR dive (Closed Circuit version only).

Plan dive

The resulting dive plan consists of a summary and a detailed listing of deco stops.

Simulation

Start real-time simulation of the dive. The computer will switch to dive mode and will show all displays in the same way as during a real dive.

Save as default

Save the parameter set as a default for the following plans, otherwise it is forgotten after switch off.

6.2 Dive plan

6.2.1 Summary

Nodeco

The runtime of the planned dive where the decompression obligation starts.

TTS

The time to surface at the ascent start.

Total

The runtime when surfacing.

CNS

The percentage of consumption of CNS toxicity limit.

NoFly

The NoFly time after the planned dive.

Dive plan 0C		1/2
Surface int:	60'	
Depth:	45 m	
Duration:	25'	
Bottom gas:	Air	
Nodeco:	4:35	
TTS:	27:00	
Total:	52:00	
CNS:	18	
NoFly:	4:20	

6.2.2 Deco stops

The description of the ascent profile and used gas mixtures.

If optimal gas is selected in the decompression settings, then the plan considers changing of gases from the list of active mixtures; the gas switch time is included.

If the current gas setting is selected in the decompression settings, then only the actual gas is used.

Dive plan 0C				2/2
Dpt[m]	Time	RunT	Gas	
45	25:00	25:00	Air	
18	2:00	29:44	EAN 50	
9	2:36	35:21	EAN 50	
6	4:01	40:22	EAN 50	
3	9:37	50:59	EAN 50	
Sum	24:15	51:59		

Section 7: Log download

Connect the USB cable included in distribution package to the USB port of your computer, tablet or mobile phone. A USB adapter will probably be necessary for mobile devices.

Select the USB connection item in the menu. The Divesoft Freedom memory can be connected as a mass storage device (like a flash drive). The connection to Windows, Mac, Linux, Android and iOS was tested, but there is no guarantee of compatibility with all operating systems and all computers. Access to the internal memory is read only.

Logs are stored in the DIVELOG folder; data from one dive is stored as one *.DLF file.



7.1 Log processing in cloud

Download files from the DIVELOG folder to your hard drive and then upload data to WETNOTES.COM. Here you can store and edit your dives, study graphs, details and much more. If you wish, you can share dives with your buddy or a group.



Visit WETNOTES.COM and explore all the possibilities that it offers!

7.2 Off-line log processing

A simple desktop application for reading dive logs directly in your PC. Requires MS Windows.

Download at www.divesoft.cz/support.

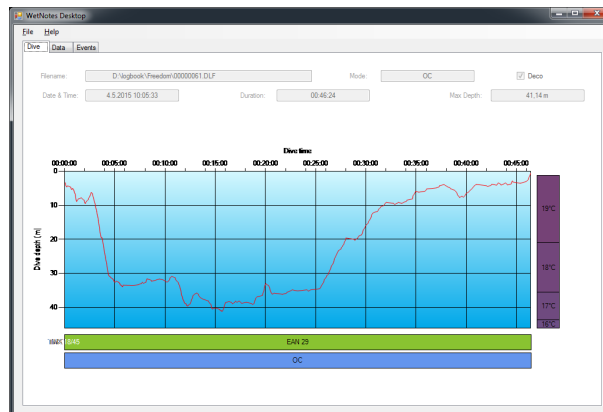

When	Depth	ppO ₂	NoDeco	Ascent	Temp	Ceiling	Setpoint
00:00:00	3.17m	0.3 bar	16:40:00	00:00:00	18 °C	0.00 m	0.0 bar
00:00:01	3.34m	0.4 bar	16:40:00	00:00:00	18 °C	0.00 m	0.0 bar
00:00:02	3.37m	0.4 bar	16:40:00	00:00:00	18 °C	0.00 m	0.0 bar
00:00:03	3.43m	0.4 bar	16:40:00	00:00:00	19 °C	0.00 m	0.0 bar
00:00:04	3.52m	0.4 bar	16:40:00	00:00:00	19 °C	0.00 m	0.0 bar
00:00:05	3.68m	0.4 bar	16:40:00	00:00:00	19 °C	0.00 m	0.0 bar
00:00:06	3.89m	0.4 bar	16:40:00	00:00:00	19 °C	0.00 m	0.0 bar
00:00:07	4.08m	0.4 bar	16:40:00	00:00:00	19 °C	0.00 m	0.0 bar
00:00:08	4.35m	0.4 bar	16:40:00	00:00:00	19 °C	0.00 m	0.0 bar
00:00:11	4.46m	0.4 bar	16:40:00	00:00:00	19 °C	0.00 m	0.0 bar
00:00:12	4.53m	0.4 bar	16:40:00	00:00:00	19 °C	0.00 m	0.0 bar
00:00:13	4.62m	0.4 bar	16:40:00	00:00:00	19 °C	0.00 m	0.0 bar
00:00:17	4.30m	0.4 bar	16:40:00	00:00:00	19 °C	0.00 m	0.0 bar
00:00:36	4.65m	0.4 bar	16:40:00	00:00:00	19 °C	0.00 m	0.0 bar
00:00:37	4.84m	0.4 bar	16:40:00	00:00:00	19 °C	0.00 m	0.0 bar
00:00:38	5.03m	0.4 bar	16:40:00	00:00:00	19 °C	0.00 m	0.0 bar
00:00:39	5.20m	0.4 bar	16:40:00	00:00:00	19 °C	0.00 m	0.0 bar
00:00:40	5.24m	0.4 bar	16:40:00	00:00:00	19 °C	0.00 m	0.0 bar
00:00:41	5.30m	0.4 bar	16:40:00	00:00:00	19 °C	0.00 m	0.0 bar
00:00:42	5.33m	0.4 bar	16:40:00	00:00:00	19 °C	0.00 m	0.0 bar
00:00:43	5.34m	0.4 bar	16:40:00	00:00:00	19 °C	0.00 m	0.0 bar
00:00:44	5.36m	0.4 bar	16:40:00	00:00:00	19 °C	0.00 m	0.0 bar
00:00:48	5.04m	0.4 bar	16:40:00	00:00:00	19 °C	0.00 m	0.0 bar
00:00:53	5.37m	0.4 bar	16:40:00	00:00:00	19 °C	0.00 m	0.0 bar
00:00:54	5.56m	0.4 bar	16:40:00	00:00:00	19 °C	0.00 m	0.0 bar
00:00:55	5.65m	0.4 bar	16:40:00	00:00:00	19 °C	0.00 m	0.0 bar
00:00:56	5.75m	0.4 bar	16:40:00	00:00:00	19 °C	0.00 m	0.0 bar
00:00:57	5.89m	0.4 bar	16:40:00	00:00:00	19 °C	0.00 m	0.0 bar
00:00:58	6.12m	0.5 bar	16:40:00	00:00:00	19 °C	0.00 m	0.0 bar
00:00:59	6.27m	0.5 bar	16:40:00	00:00:00	19 °C	0.00 m	0.0 bar
00:01:00	6.40m	0.5 bar	16:40:00	00:01:00	19 °C	0.00 m	0.0 bar
00:01:01	6.49m	0.5 bar	16:40:00	00:01:00	19 °C	0.00 m	0.0 bar
00:01:02	6.59m	0.5 bar	16:40:00	00:01:00	19 °C	0.00 m	0.0 bar
00:01:03	6.72m	0.5 bar	16:40:00	00:01:00	19 °C	0.00 m	0.0 bar
00:01:04	6.92m	0.5 bar	16:40:00	00:01:00	19 °C	0.00 m	0.0 bar
00:01:05	7.21m	0.5 bar	16:40:00	00:01:00	19 °C	0.00 m	0.0 bar
00:01:06	7.55m	0.5 bar	16:40:00	00:01:00	19 °C	0.00 m	0.0 bar
00:01:07	7.93m	0.5 bar	16:40:00	00:01:00	19 °C	0.00 m	0.0 bar
00:01:08	8.26m	0.5 bar	16:40:00	00:01:00	19 °C	0.00 m	0.0 bar
00:01:09	8.55m	0.5 bar	16:40:00	00:01:00	19 °C	0.00 m	0.0 bar
00:01:10	8.71m	0.5 bar	16:40:00	00:01:00	19 °C	0.00 m	0.0 bar
00:01:11	8.84m	0.5 bar	16:40:00	00:01:00	19 °C	0.00 m	0.0 bar
00:01:12	8.89m	0.5 bar	16:40:00	00:01:00	19 °C	0.00 m	0.0 bar
00:01:17	8.48m	0.5 bar	16:40:00	00:01:00	19 °C	0.00 m	0.0 bar
00:01:22	8.13m	0.5 bar	16:40:00	00:01:00	19 °C	0.00 m	0.0 bar
00:01:40	7.80m	0.5 bar	16:40:00	00:01:00	19 °C	0.00 m	0.0 bar
00:01:46	8.14m	0.5 bar	16:40:00	00:01:00	19 °C	0.00 m	0.0 bar
00:01:57	8.55m	0.5 bar	16:40:00	00:01:00	19 °C	0.00 m	0.0 bar

Section 8: System

8.1 System check

There is detailed version, license, settings, battery and pressure sensor information described on 5 screens (6 for CCR version).

8.2 Service functions

Service functions are primarily intended to support a qualified technician or to be performed with the recommendation of the manufacturer's technical support.

These functions are not blocked but no end user support is provided. A detailed description is beyond the scope of this manual. An IT specialist can understand most of them without further description.

The service functions menu is accessible via the coded key press (press both keys; release one key and press it again; release both keys).

8.2.1 Debug

All debug information is read only. There is no risk associated with browsing them just for curiosity.

Sensors

A detailed state of all sensors.

Deco model

The state of the decompression model is described in detail on 5 screens (including the compartment saturation graph).

Scheduler

The firmware task list with information specifying the system footprint.

Variables

The values of some internal variables.

8.2.2 Test

There is no risk associated with performing these tests just for curiosity while on the surface.

Buttons

It runs a simple test of both buttons.

Vibration

It runs a short test of the vibration.

Display

A red, green and blue screen will be displayed for the display test.

Watchdog

Watchdog is a timer that is used to detect and recover from firmware malfunctions. You can intentionally hang the computer with this test. Do not use underwater!

Test dive

The test dive is used by the manufacturer or an authorized service for the pressure sensor calibration and tightness test. It is similar to the gauge mode. The test dive log will be stored, but clearly marked as a test dive. The test dive is not included in the log summary.

8.2.3 Demo dive

The test dives are suitable for those interested in a demonstration of the Divesoft Freedom features. There is no risk associated with the demo dive performing.

During a demo dive almost all functions can be tested on the surface. One exception is the pressure sensor reading. Also O₂ sensors connected with a cable can't be used for the measured CCR dive mode.

The depth profile is provided and decompression gas mixtures are automatically switched. The Emergence du Ressel demo dive uses the authentic depth profile from the penetration through the first siphon of this French cave.

Demo dive logs can be permanently stored into the log memory. The oldest dive logs will be replaced by the new demo dive log if the memory is full. Demo dive logs are clearly marked.

A demo dive log, if this is the last dive, can be erased later using Demo dive → Erase demo log.

The single bottom-level demo dive functionality is equivalent to the dive simulation in the dive planner. See also [Dive planner](#) (page 45).

8.2.4 Syslog

The system events log list. All information is read only.

8.2.5 Miscellaneous

Warning: These functions can alter values of internal variables or/and the state of the Divesoft Freedom. Use them with caution and only if you understand the consequences.

Force Dive Start

It can be used for an extraordinary shallow dive in a place where initial submersion to a depth greater than 1.5 m is impossible. This also can be used if the automatic dive start failed for any reason (e.g. submersion recognition algorithm is confused by previous pressure changes unrelated to diving).

Force Dive End

If the surface pressure (zero depth) was incorrectly detected and the computer "dives" while on the surface then the dive can be forced to stop with this function.

Browse config

Every setting can be read and changed. The majority of settings can also be changed using an ordinary setup; the equivalent minimum and maximum limits for every setting will be applied. There are only few internal configuration parameters intended for special use.



Reset deco data

The residual inert gas saturation from previous dive(s) will be removed. Only use this function to give the computer to another diver whose surface interval is sufficient for a complete desaturation.

Bootloader

Restart to the bootloader mode for the firmware update or the version upgrade.

Connect the USB cable included in distribution package to the USB port of your computer where the DSLoader software is properly installed. See www.divesoft.cz/support for further information and for the firmware download.

The version license is fixed to the unit's serial number and non-transferable to the other Divesoft Freedom computers.



Section 9: Apps

9.1 Analyzer

Warning: O₂ sensor has to be calibrated before use!

Warning: do not use expired or malfunctioning sensors!

The Divesoft Freedom computer can be used as a nitrox analyzer if an oxygen sensor is attached. The O₂ sensor housing can be ordered separately.

O₂ sensors previously used in rebreather can be used, if they are still able to measure full range of oxygen pressures in atmospheric pressure safely.

9.1.1 Measuring

Connect housing with O₂ sensor, start the Analyzer application and use as any other nitrox analyzer.

Use only barely audible stream of nitrox from SCUBA tank valve and be sure to press housing inlet tightly.

9.1.2 Calibration

Analyzer can be calibrated with air.

Press lower key to start calibration. Confirm calibration with upper key press when mV reading is stable.

Old sensor may but may not be detected by low voltage during calibration using air (see the sensor manufacturer’s datasheet). Reliable method is to calibrate the sensor with air and then check the maximum range with pure oxygen.

Recalibrate analyzer sensor at least 24 h before measuring. Calibration process takes altitude (atmospheric pressure) and temperature into account.

Rebreather sensor calibration has no connection with analyzer sensor calibration.

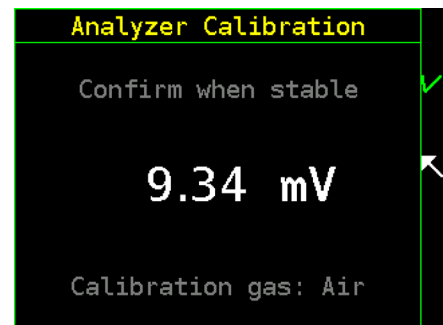
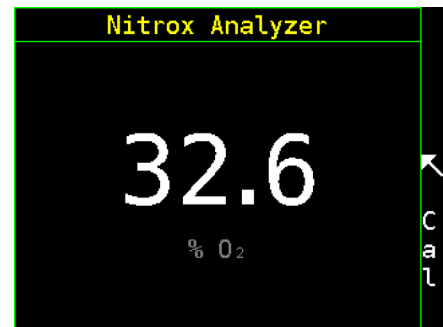

9.2 Games

Do not disable error messages and notifications related to decompression if the games are played during a deco stop.

Ensure to not accidentally reposition while playing during a dive. Check the pressure gauges on a regular basis. Playing a game will reduce your attention. Remember: you want to decompress safely, not just achieve a higher level in the game!

The games were tested on children. Nobody was hurt.

9.2.1 Sokoban

Sokoban is a type of transport puzzle, in which the player (a diving mask with snorkel) pushes tanks or crates around in a warehouse, trying to get them to storage locations (red dots).

The game is played on a board of squares, where each square is either a floor or a wall. Some floor squares contain tanks, and some floor squares are marked as storage locations.

The player is confined to the board, and may move horizontally or vertically onto empty squares (never through walls or boxes). The player can also move into a tank, which pushes it into the square beyond. Tanks may not be pushed into other tanks or walls, and they cannot be pulled. The puzzle is solved when all tanks are in the storage locations.

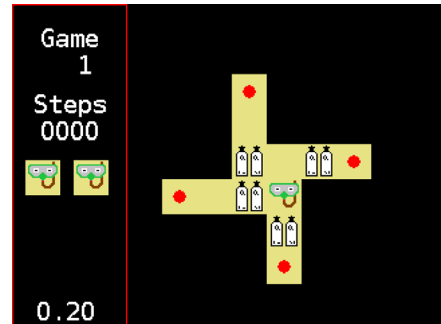

9.2.2 Snake

Snake is a game where the player maneuvers a line which grows in length, with the line itself being a primary obstacle.

The player controls the head of the snake. As it moves forward, it leaves a trail behind, resembling a moving snake. The snake has a specific length. The player loses when the snake runs into the screen border, a trail or another obstacle, or eats poison (skull), or starves to death.

The snake lose its length slowly (every 30 steps), and when it is too short, it dies from starvation.

The player attempts to eat fish by running into them with the head of the snake. Each fish eaten makes the snake longer, so maneuvering becomes progressively more difficult.



Section 10: Hardware

10.1 Charging

Use the USB charger included in the distribution package or any USB port suitable for charging. The included charger is international; it can be connected to the all major wall sockets.

The Freedom's connector is situated between the buttons. If the connector is protected by the lid, then unscrew the connector lid before attaching the cable.

The computer may or may not be switched on during charging. If the computer is switched on, then the icon in the top-right corner on the surface screen indicates the state of charge.



Charging in progress



Battery is full, but plugged to the charger

It takes about 5 hours to charge from near empty state to fully charged.

Maximum charging current is less than 500 mA, so there is no difference between charging using the charger or charging from an ordinary computer USB port.

Charge the battery at least once every six months.

10.1.1 Powering in hyperbaric environment

The Divesoft Freedom cannot be powered externally and recharged during a dive (e.g. in hyperbaric chamber, in diving bell or mounted on ROV) without a special setting which is available only on request. The unit must be individually tested prior to such use.

10.2 Wrist mount

If you prefer a strap, pass the strap under the bars. Use the Velcro on the strap to tighten.

If you prefer a bungee, then remove the screws holding the bars using a Torx screwdriver (T 20 size). Don't use any other tool; screw heads are easily damaged.

If you want to use a silicon protective sleeve, install it before installing the bungee. It is not possible to install the sleeve on the computer with bungee already installed.

Pass the bungee through the threaded holes and secure with a knot. There is a special thread inside the holes which does not damage the bungee.

Use a small flame to melt the braid of the bungee and make a tip on the end of it for easier pass-through.

Both the strap and bungee are included.

In any case, the opening on the back of the computer must remain freely accessible. When you mount the computer directly on bare skin avoid closing the opening. The pressure sensor is located there.

10.3 Control elements

The following inputs and combinations thereof are differentiated:

- Press upper key
- Press lower key
- Press both keys
- Long press upper key
- Long press lower key
- Long press both keys
- Coded key press (press both keys, then release one key and press it again, then release both keys)
- Tilt away from yourself
- Tilt toward yourself
- Tilt to the left
- Tilt to the right
- Tap the display glass
- Shine a light on the display



“Long press” means pressing the key for more than 2.5 seconds. The key-press operation is terminated at the moment the key is released or, in case of pressing both keys, when the last key is released.

The upper/lower keys and directions of tilting are determined by the display orientation, depending on whether it is set up for the left or right hand.

Tilting can be changed in the configuration to tapping on the computer body from any of the four sides.

Note: Perform the [Horizontal calibration](#) (page 41) if there is no valid response to tilting or tapping.

10.4 Physical dimensions

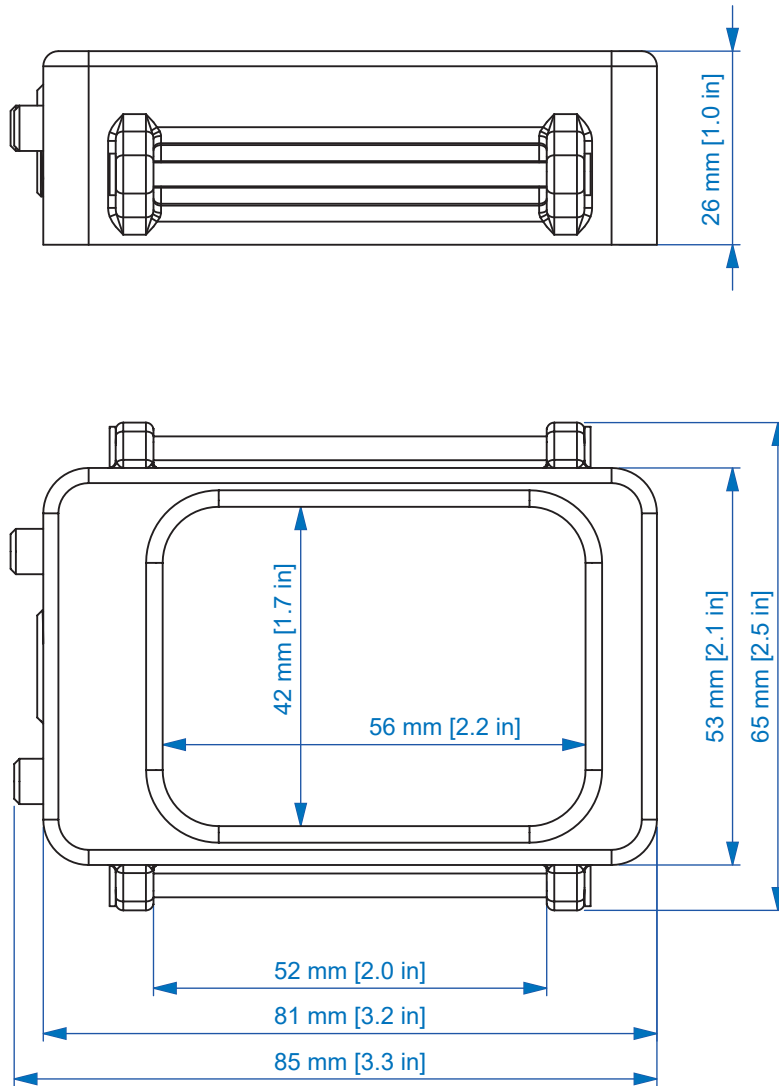

10.5 O₂ sensor cable

The cable equipped with the Molex connectors is included in the Closed Circuit version of the Divesoft Freedom distribution package or can be ordered separately.

The technical design of the connections on a specific type of rebreather is not the subject of this user manual.



Cable is delivered with terminals Molex 08-55-102 crimped, connectors Molex 22-01-3037 are packed separately, to be mounted after passing through cable gland.

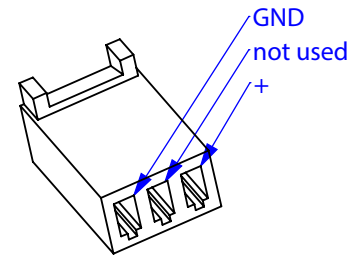

Connector Molex 22-01-3037

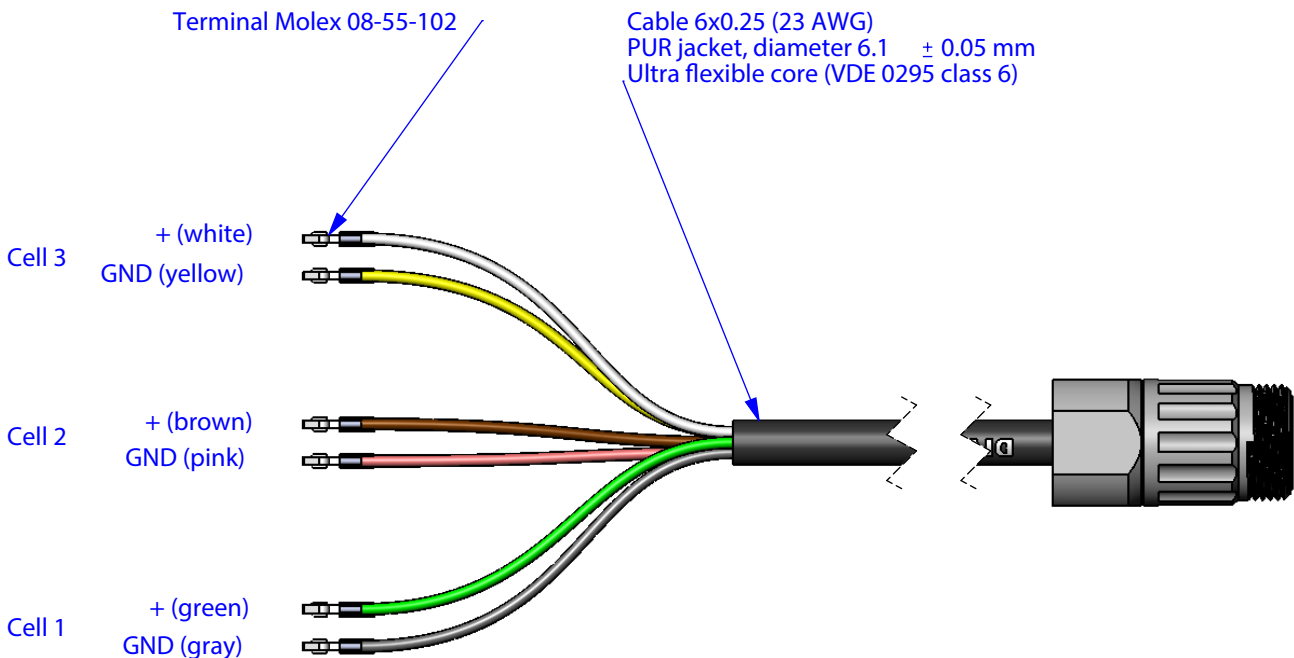

10.6 Environmental specifications

Recommended operating conditions

Recommended operating temperature range: 0 °C to 40 °C (32 °F to 104 °F)

Maximum operating conditions

Permitted short term operating temperature range: -10 °C to 45 °C (14°F to 113 °F)
Consider the reduced battery capacity at low temperatures.

Long term storage conditions

Storage temperature range: 10 °C to 35 °C (50°F to 95°F)
Don't expose to direct sunlight

10.7 Compliance

10.7.1 CE marking

Divesoft s.r.o. hereby declares that the Divesoft Freedom is in compliance with the essential requirements and other relevant provisions of Directive 1999/5/EC.

10.7.2 EN 13319

Independent conformity assessment was performed to the harmonized European depth gauge standard EN 13319:2000.

10.7.3 FCC compliance

This device complies with Part 15 of the FCC Rules. Operation is subject to the following two conditions: (1) this device may not cause harmful interference, and (2) this device must accept any interference received, including interference that may cause undesired operation.

10.7.4 Industry Canada (IC) Compliance Notice

This device complies with Industry Canada license-exempt RSS standard(s). Operation is subject to the following two conditions: (1) this device may not cause interference, and (2) this device must accept any interference, including interference that may cause undesired operation of the device.

This Class B digital apparatus complies with Canadian ICES-003.

10.8 Disposal of waste equipment

Users in private households in the European Union

This symbol on the product and accompanying documents means that used electrical and electronic products should not be mixed with general household waste. For proper treatment, recovery and recycling, please take these products to designated collection points where they will be accepted free of charge. Alternatively, in some countries you may be able to return your products to your local retailer upon purchase of an equivalent new product.

Disposing of this product correctly will help save valuable resources and prevent any potential negative effects on human health and the environment, which could otherwise arise from inappropriate waste handling.



For business users in the European Union

If you wish to discard electrical and electronic equipment, please contact your dealer or supplier for further information.

Information on Disposal in other Countries outside the European Union

This symbol is only valid in the European Union. If you wish to discard this product please contact your local authorities or dealer and ask for the correct method of disposal.